

ATLAS-W2D2

Measurement for
Masterclass-in-a-box
Data Set 2

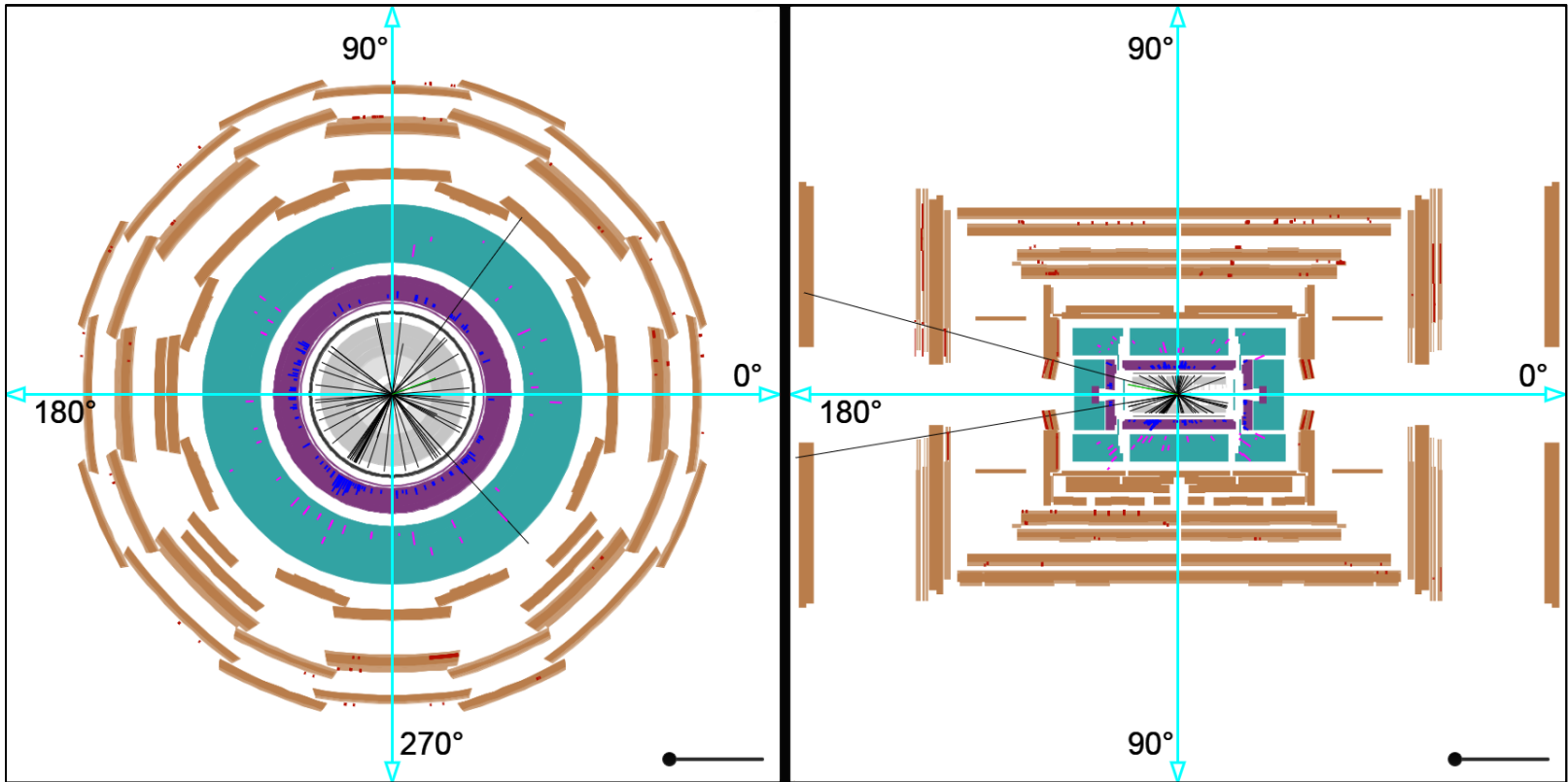

x-y view: measure ϕ

z-y view: measure θ

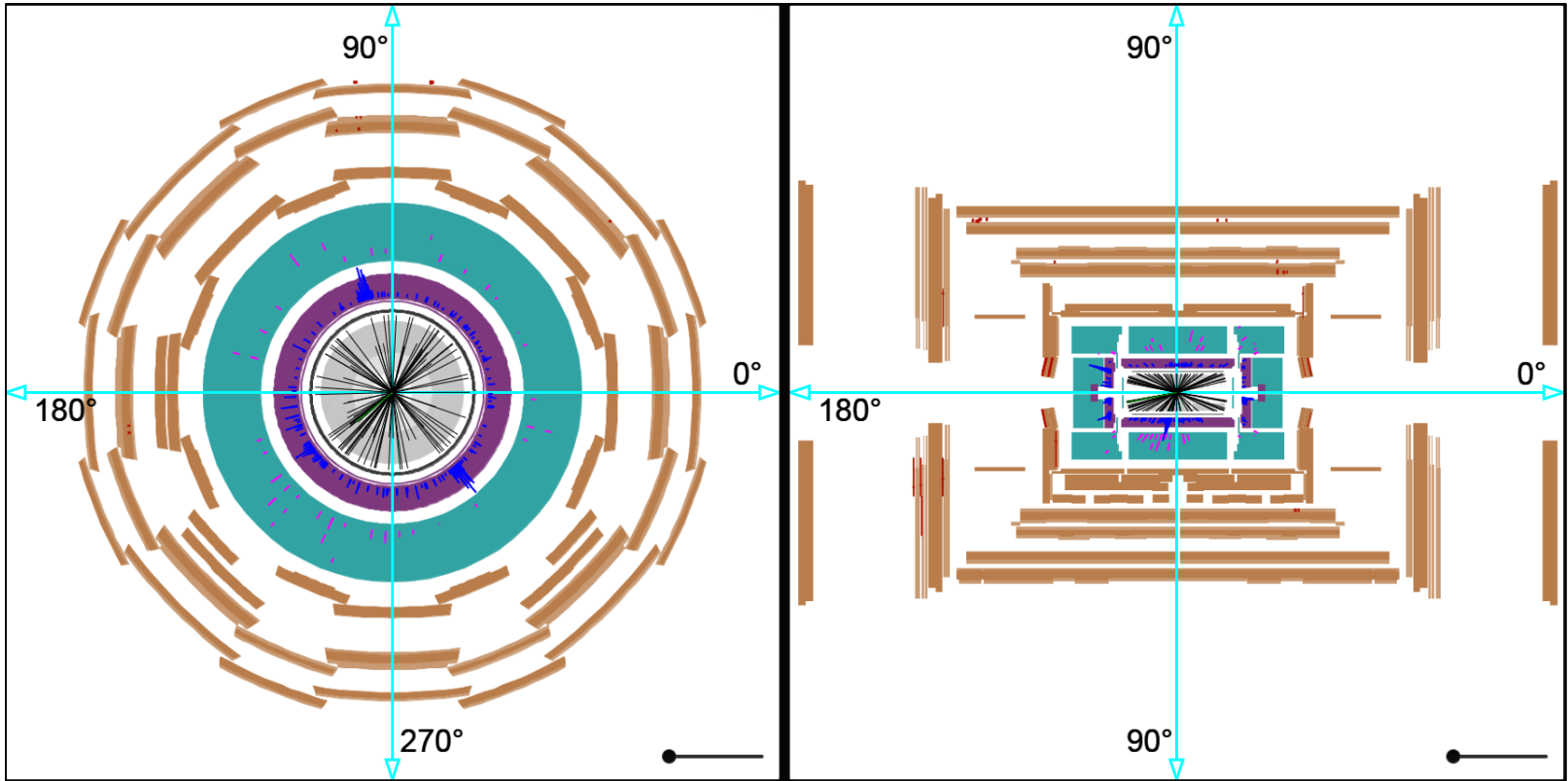

x-y view: measure ϕ

z-y view: measure θ

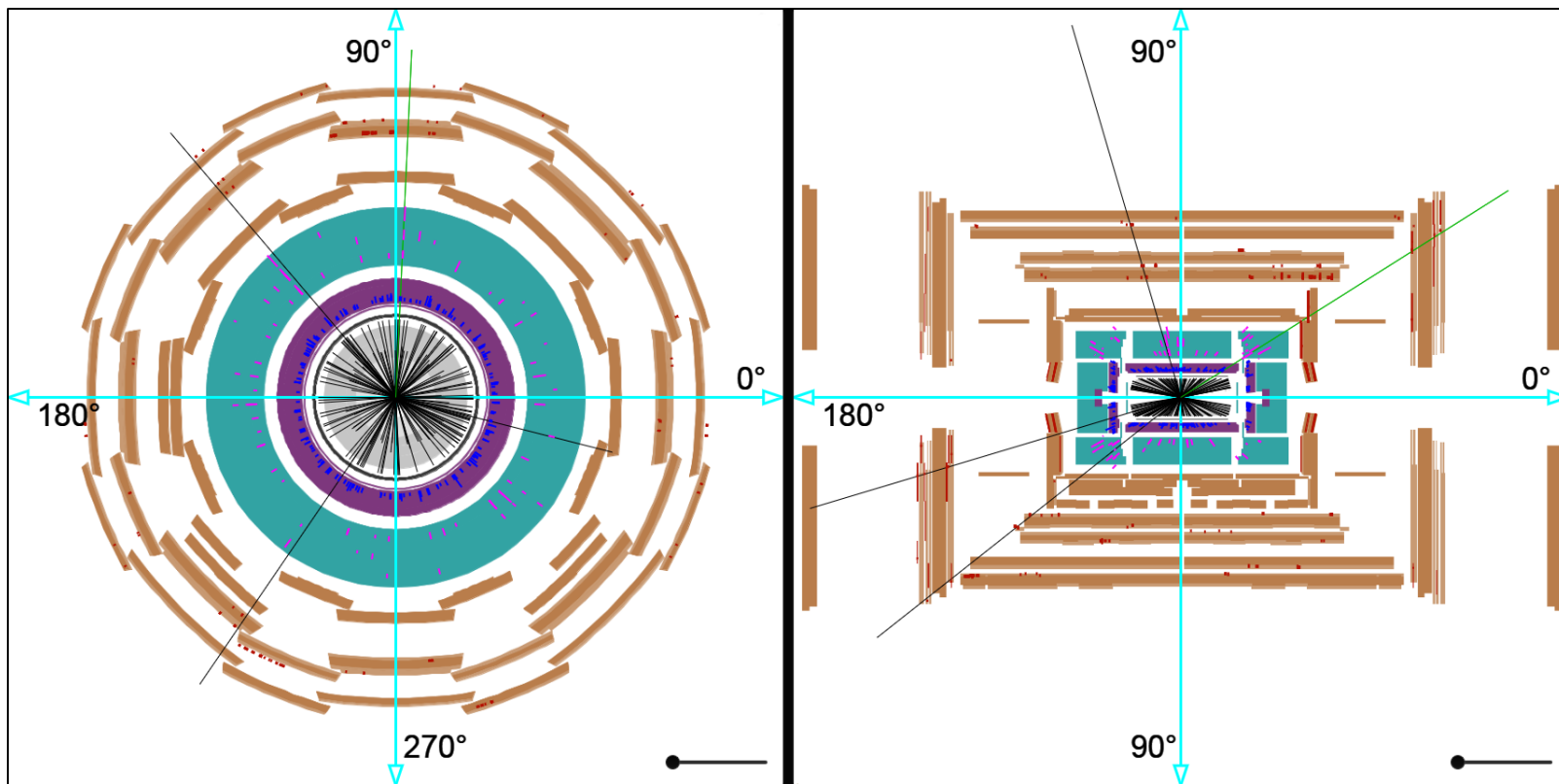

x-y view: measure ϕ

z-y view: measure θ

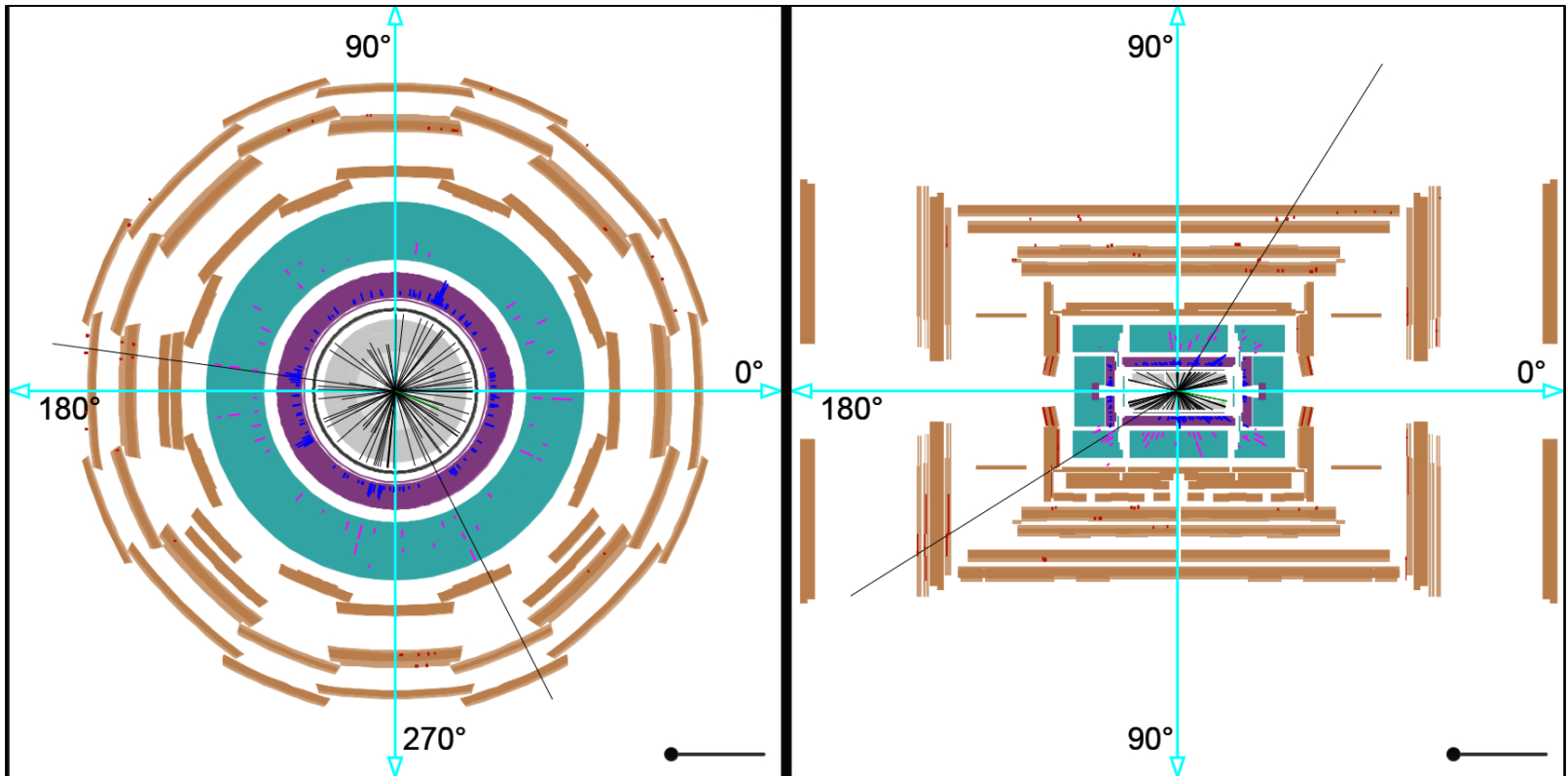

x-y view: measure ϕ

z-y view: measure θ

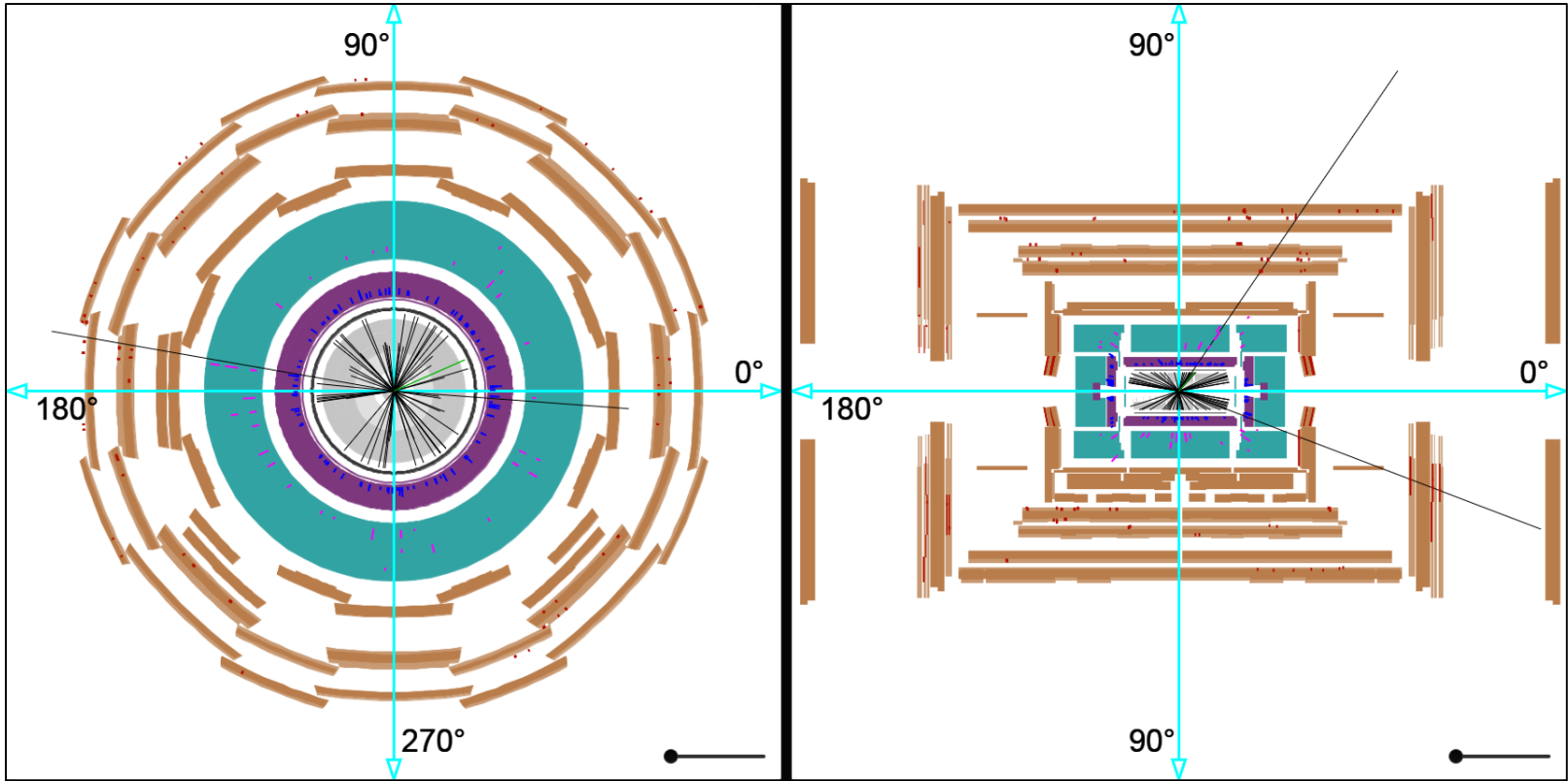

x-y view: measure ϕ

z-y view: measure θ

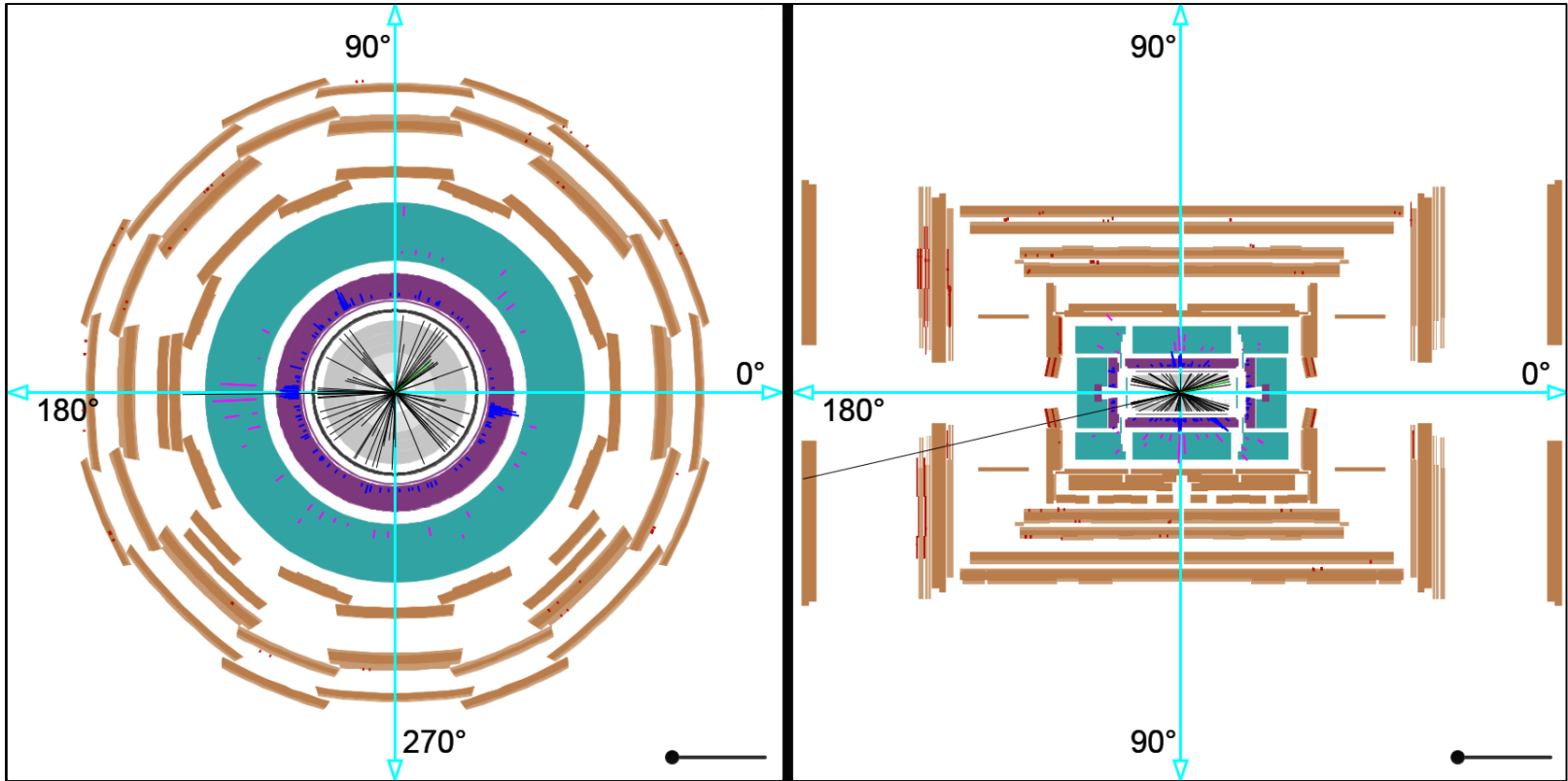

x-y view: measure ϕ

z-y view: measure θ

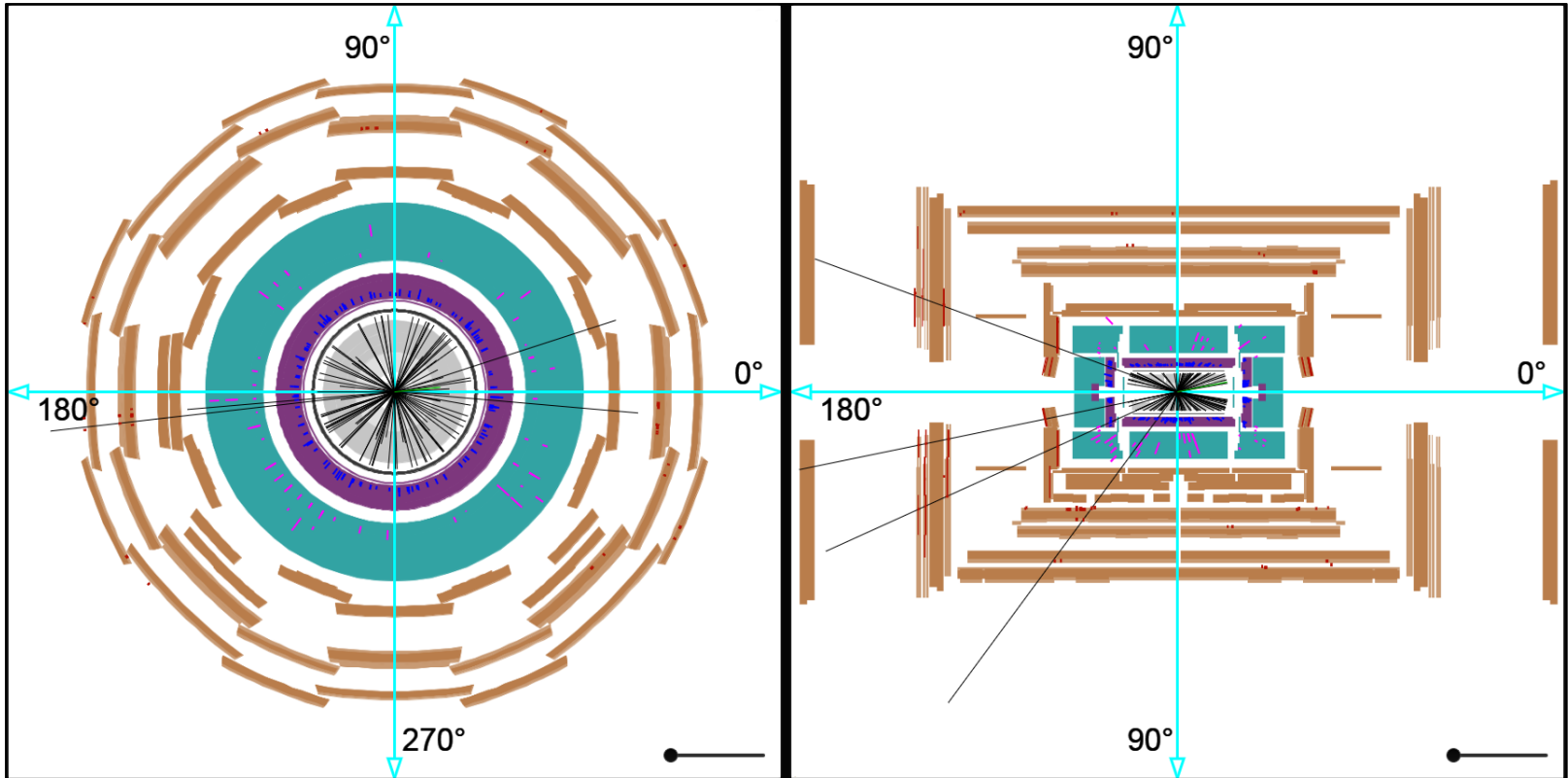

x-y view: measure ϕ

z-y view: measure θ

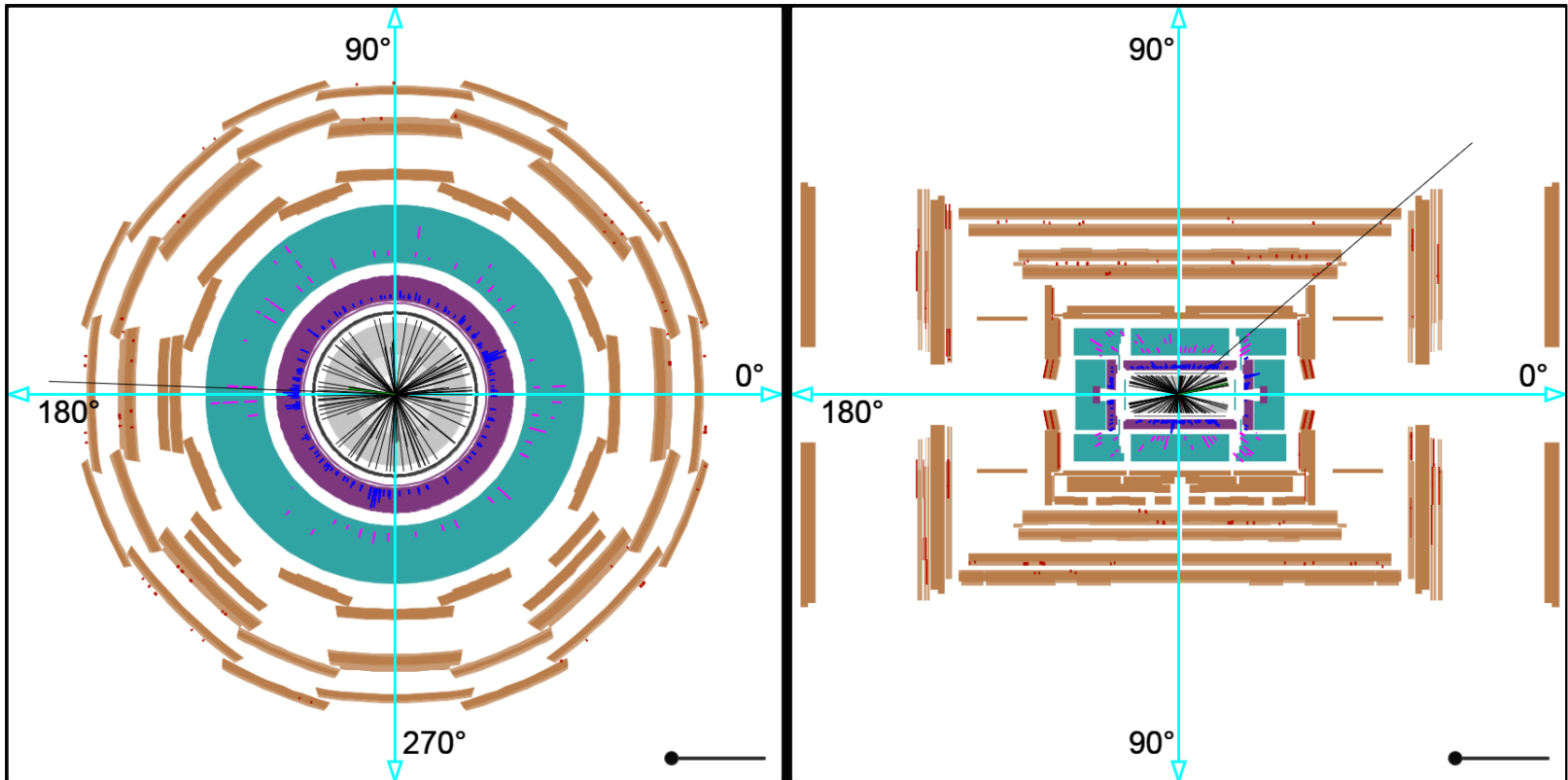

x-y view: measure ϕ

z-y view: measure θ

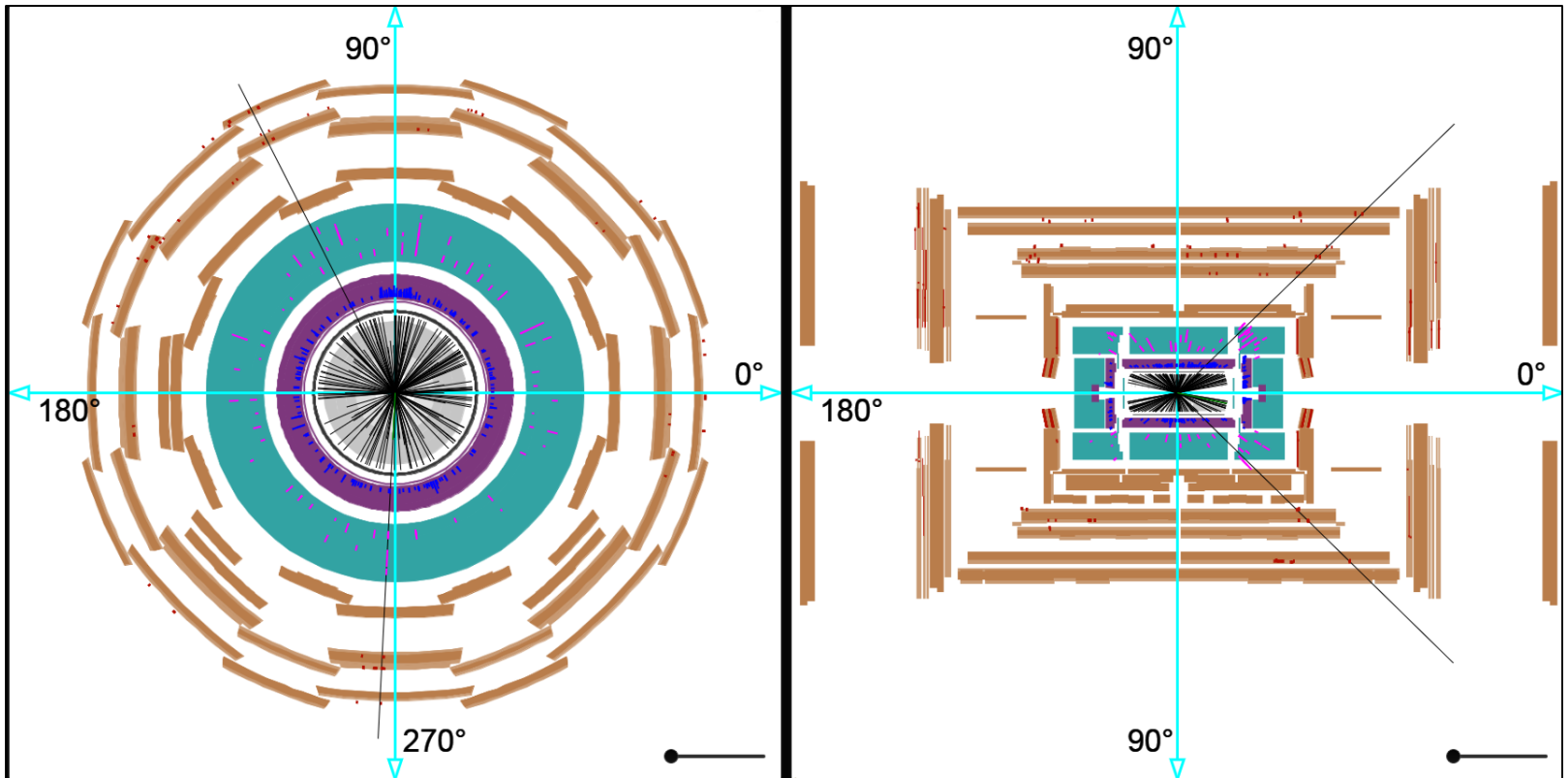

x-y view: measure ϕ

z-y view: measure θ

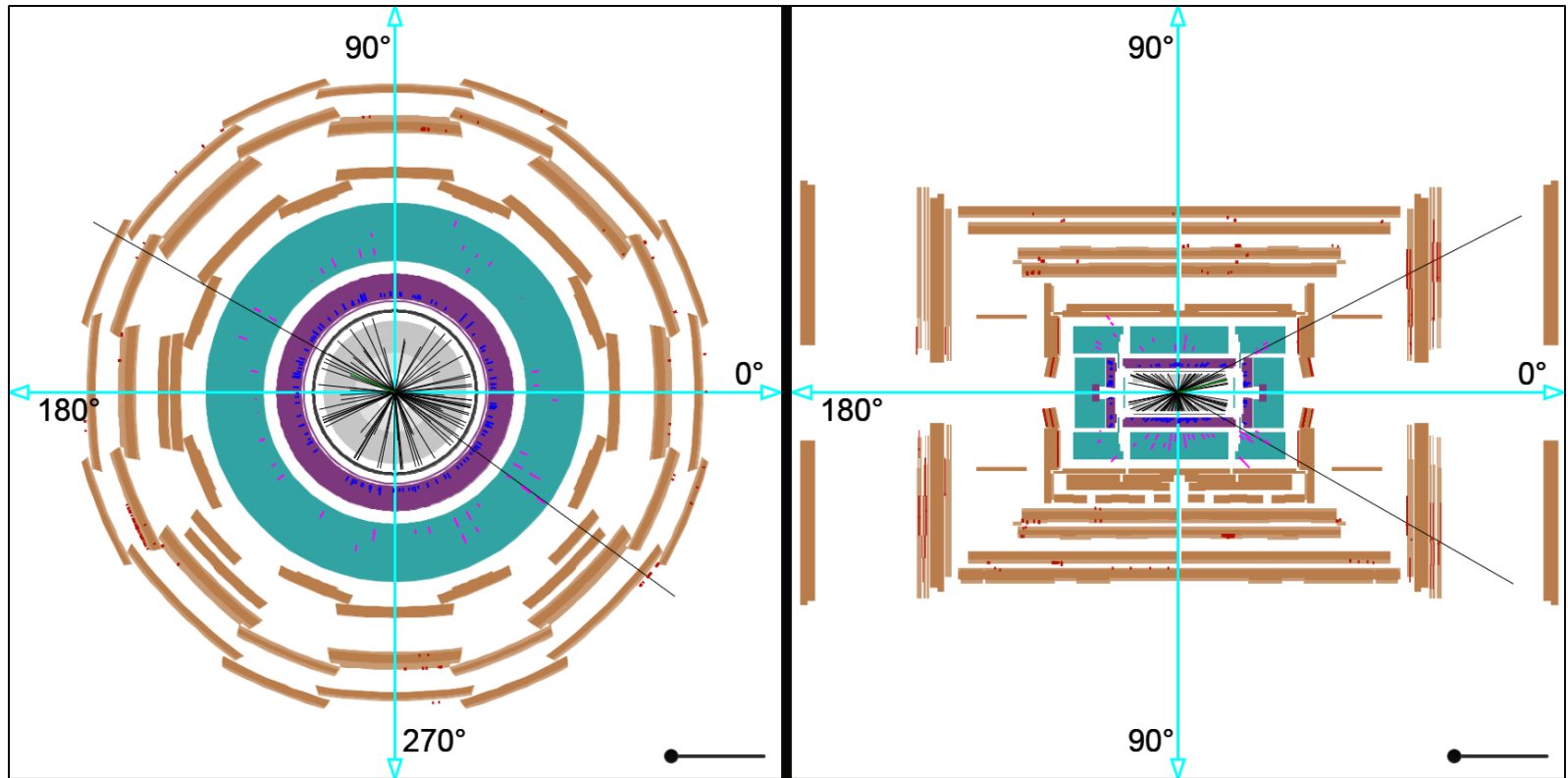

x-y view: measure ϕ

z-y view: measure θ

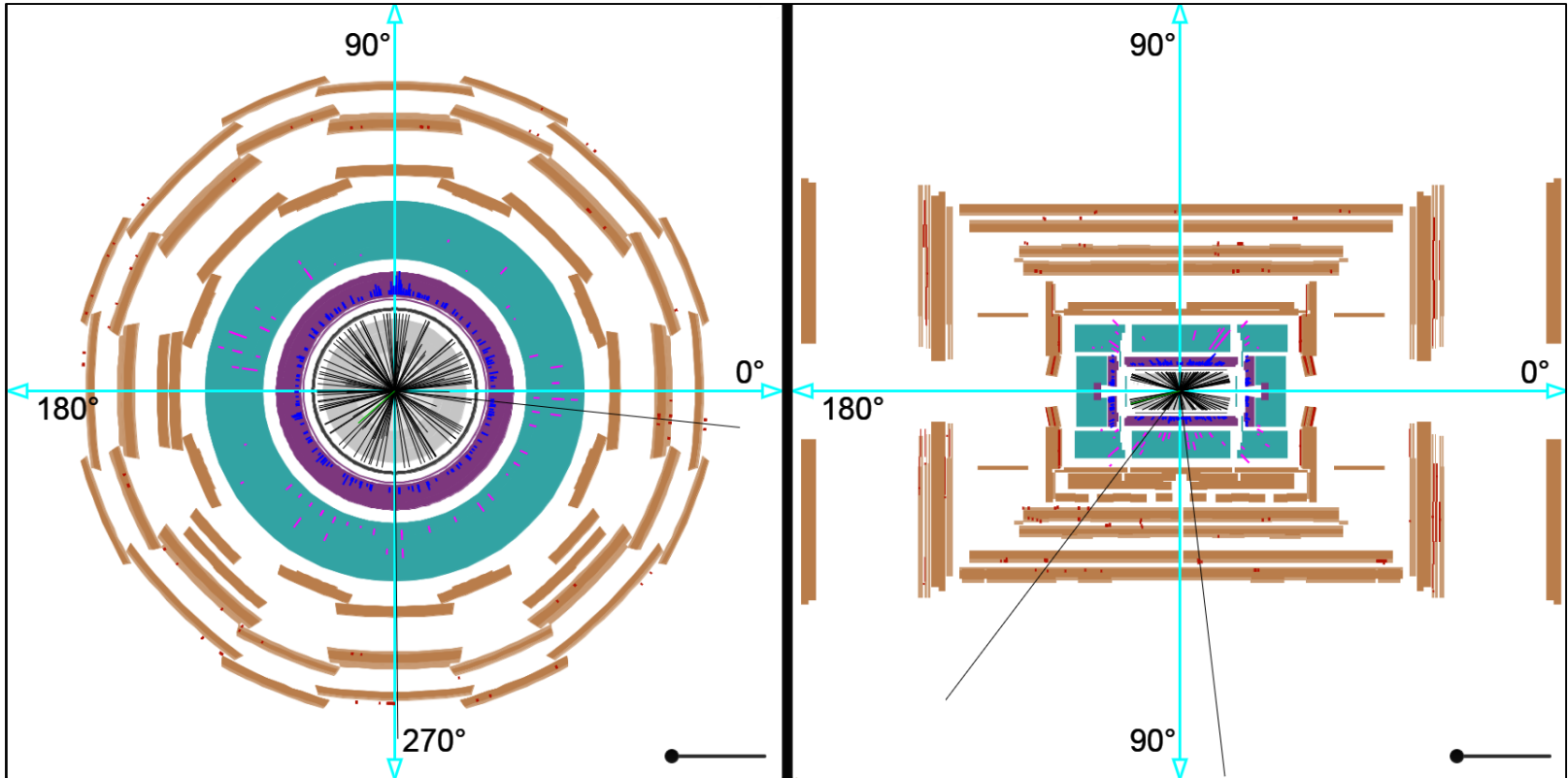

x-y view: measure ϕ

z-y view: measure θ

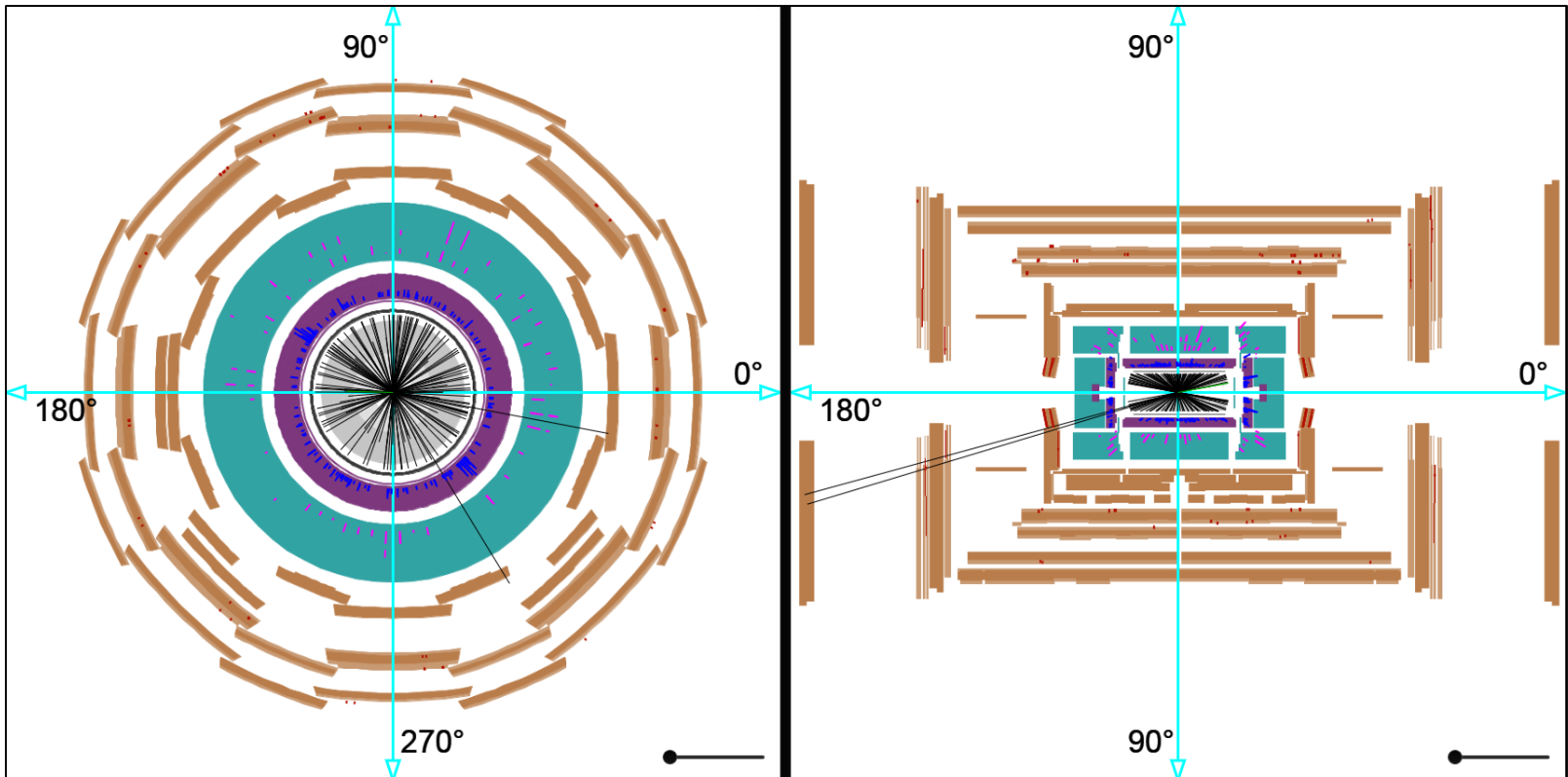

x-y view: measure ϕ

z-y view: measure θ

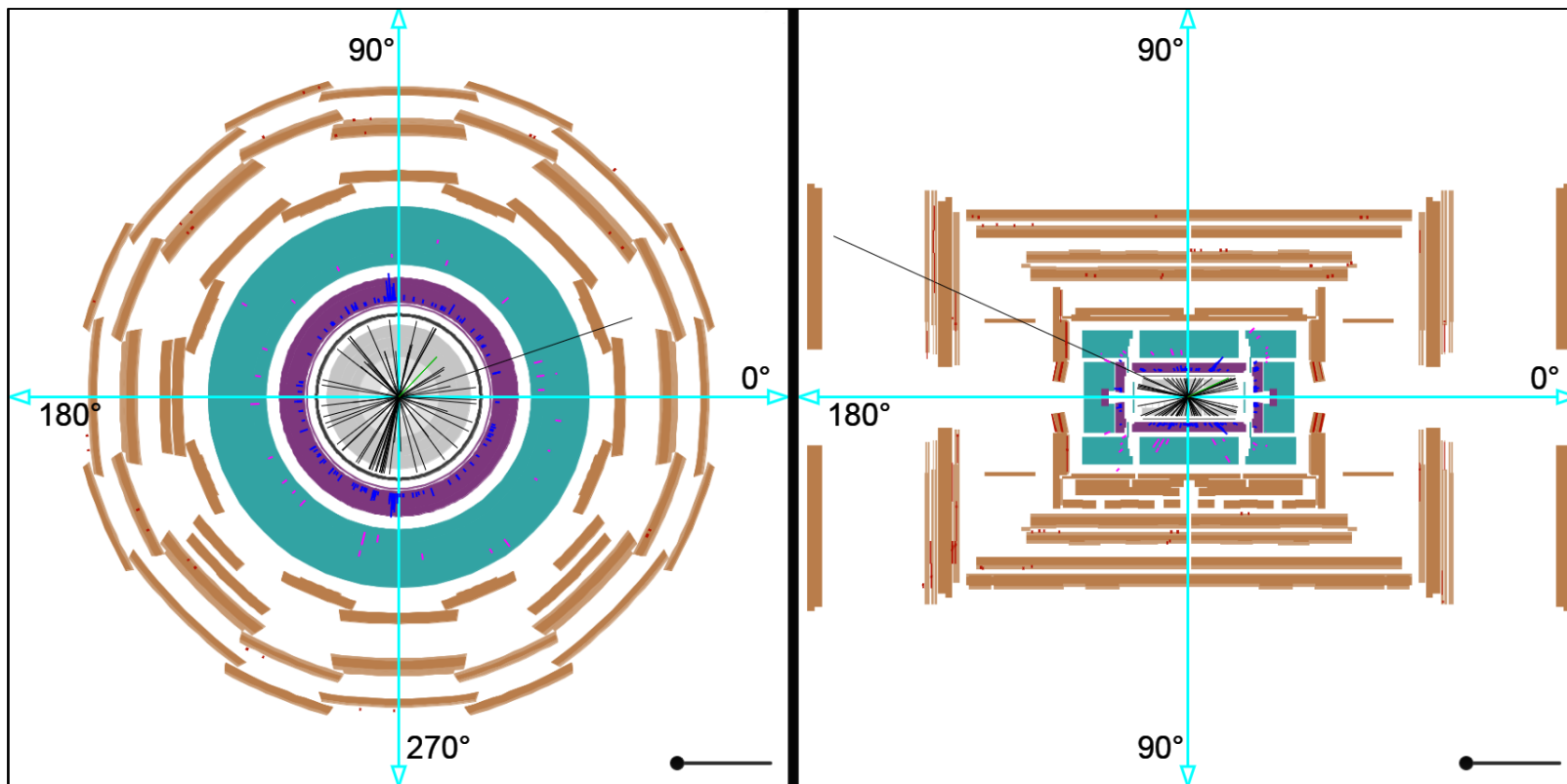

x-y view: measure ϕ

z-y view: measure θ

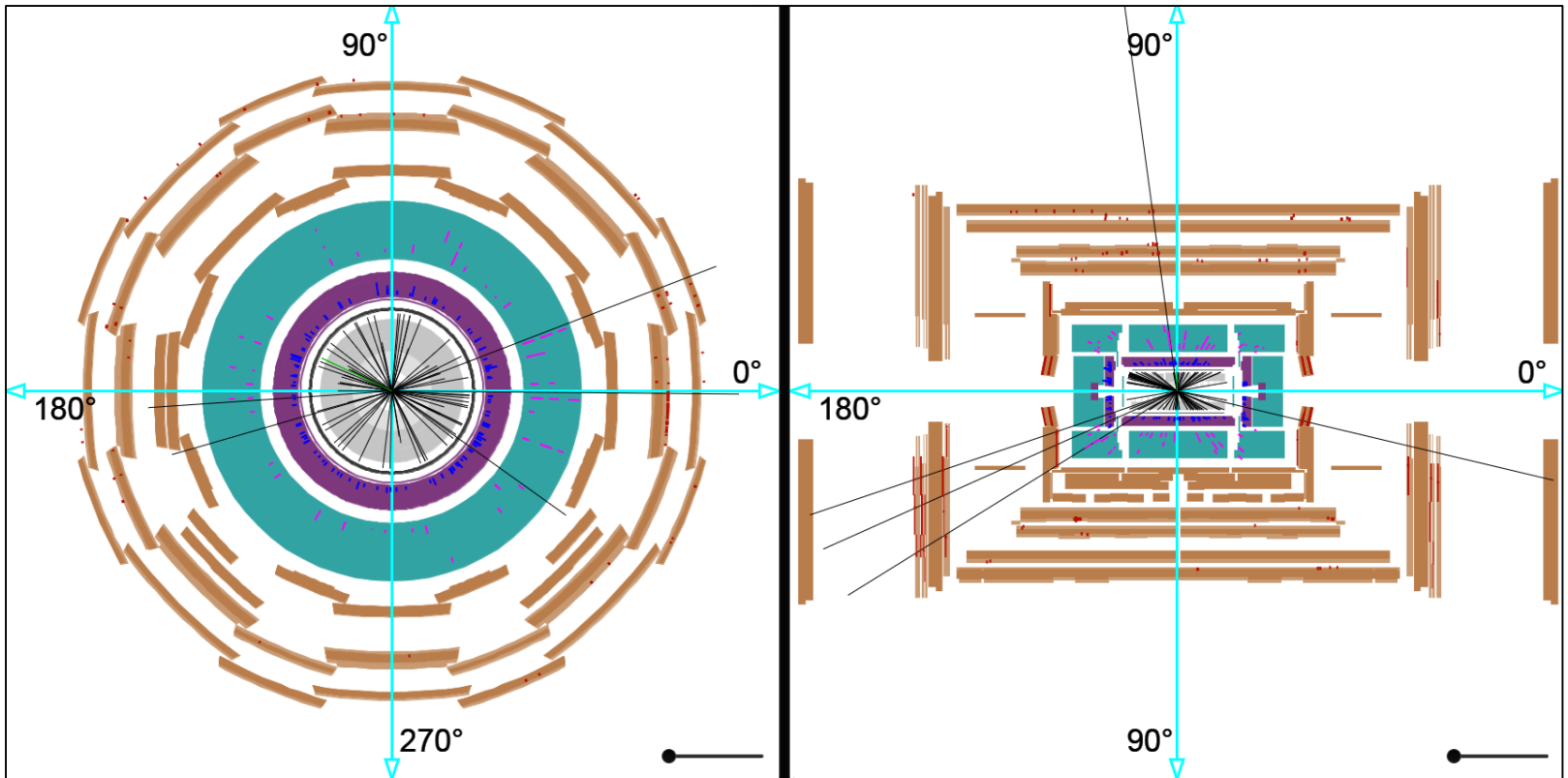

x-y view: measure ϕ

z-y view: measure θ

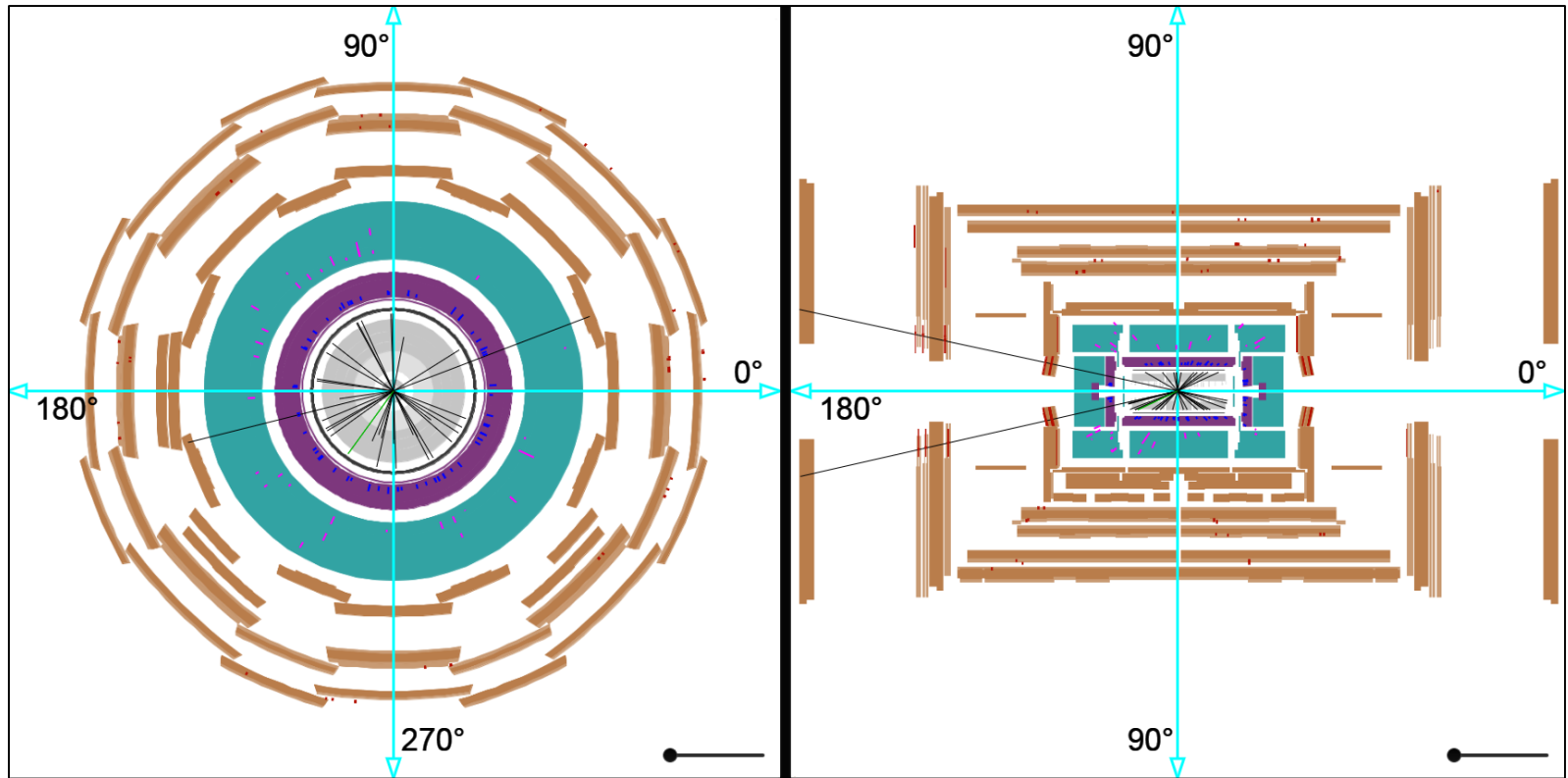

x-y view: measure ϕ

z-y view: measure θ

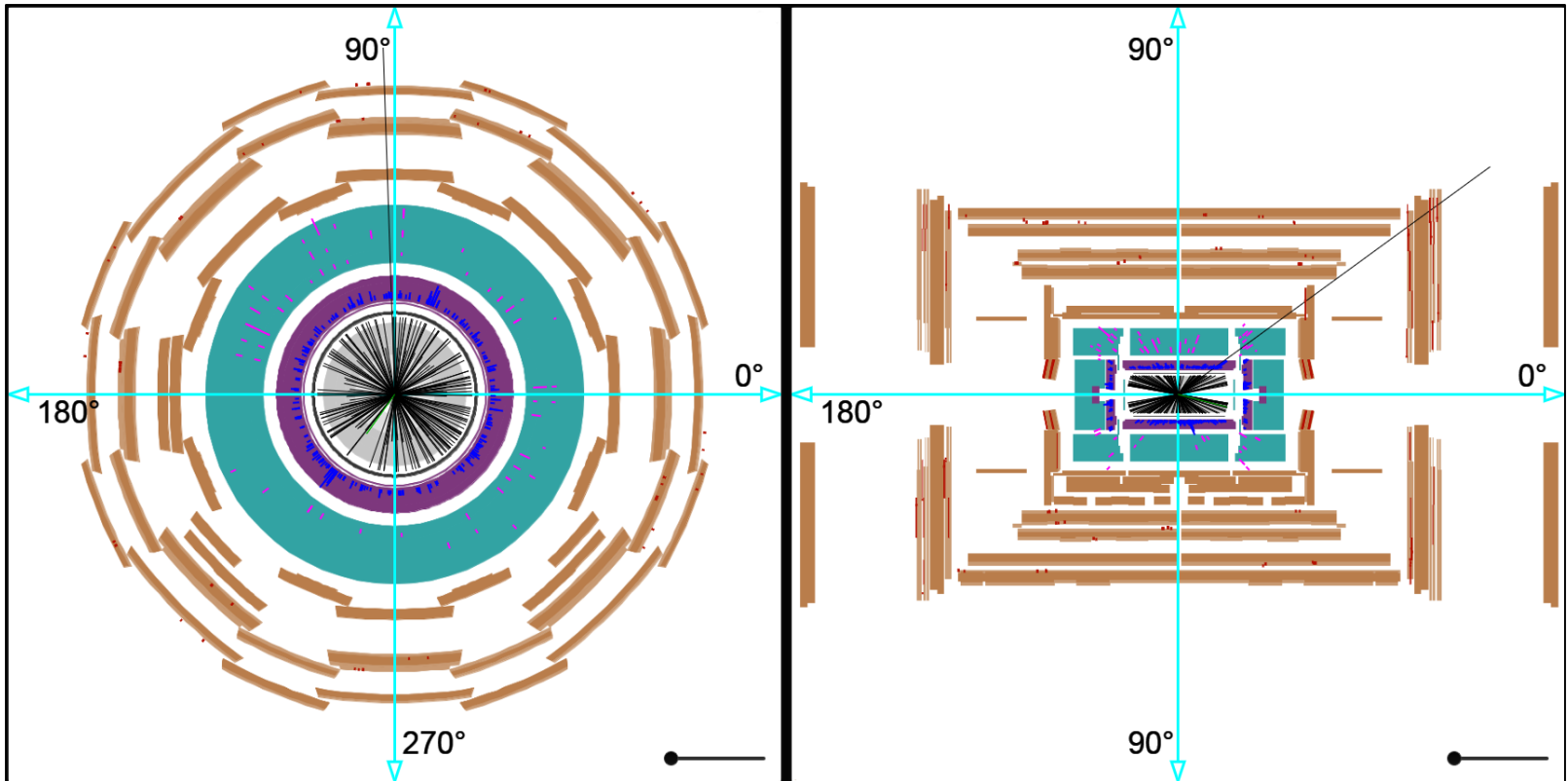

x-y view: measure ϕ

z-y view: measure θ

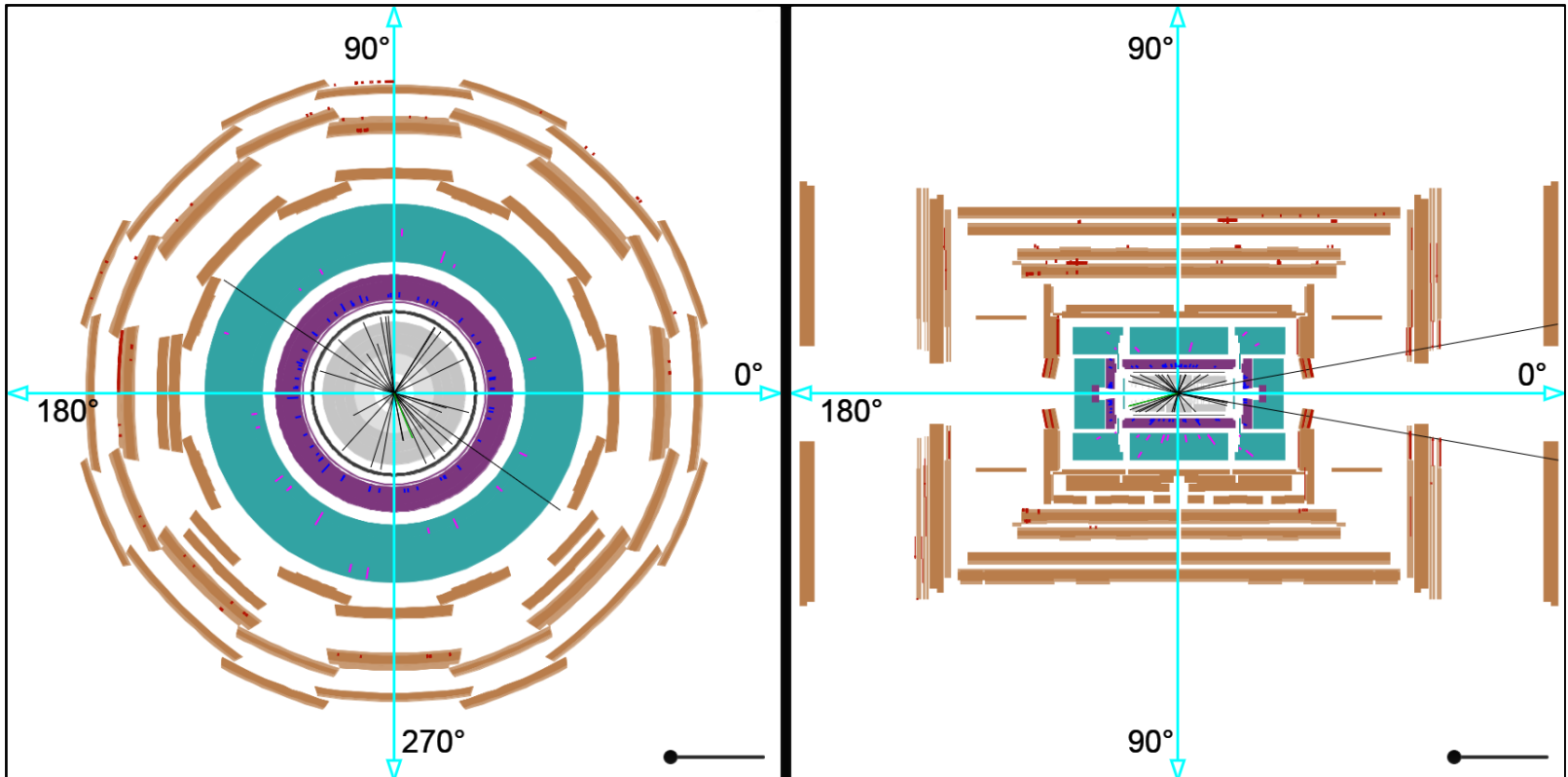

x-y view: measure ϕ

z-y view: measure θ

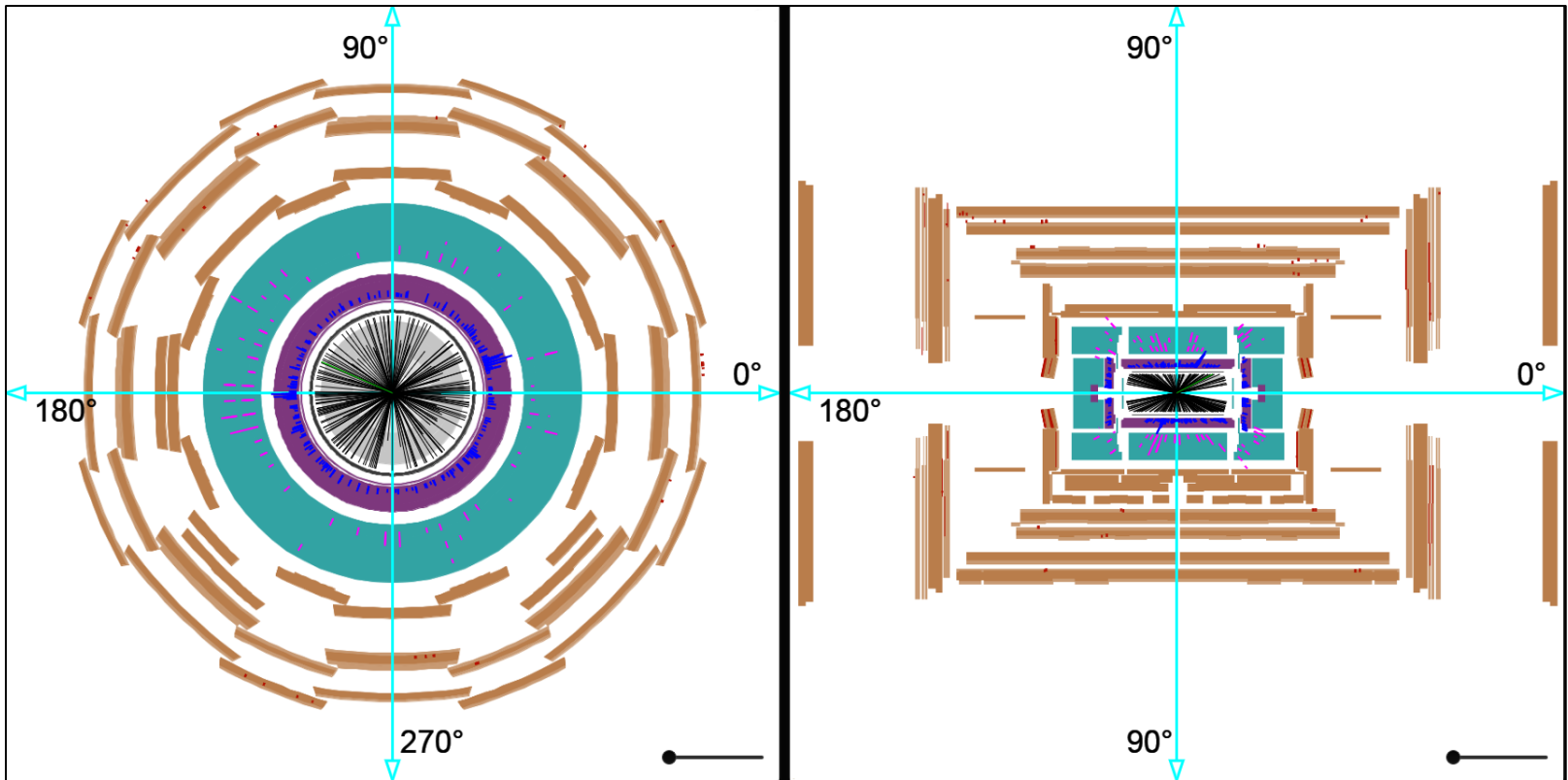

x-y view: measure ϕ

z-y view: measure θ

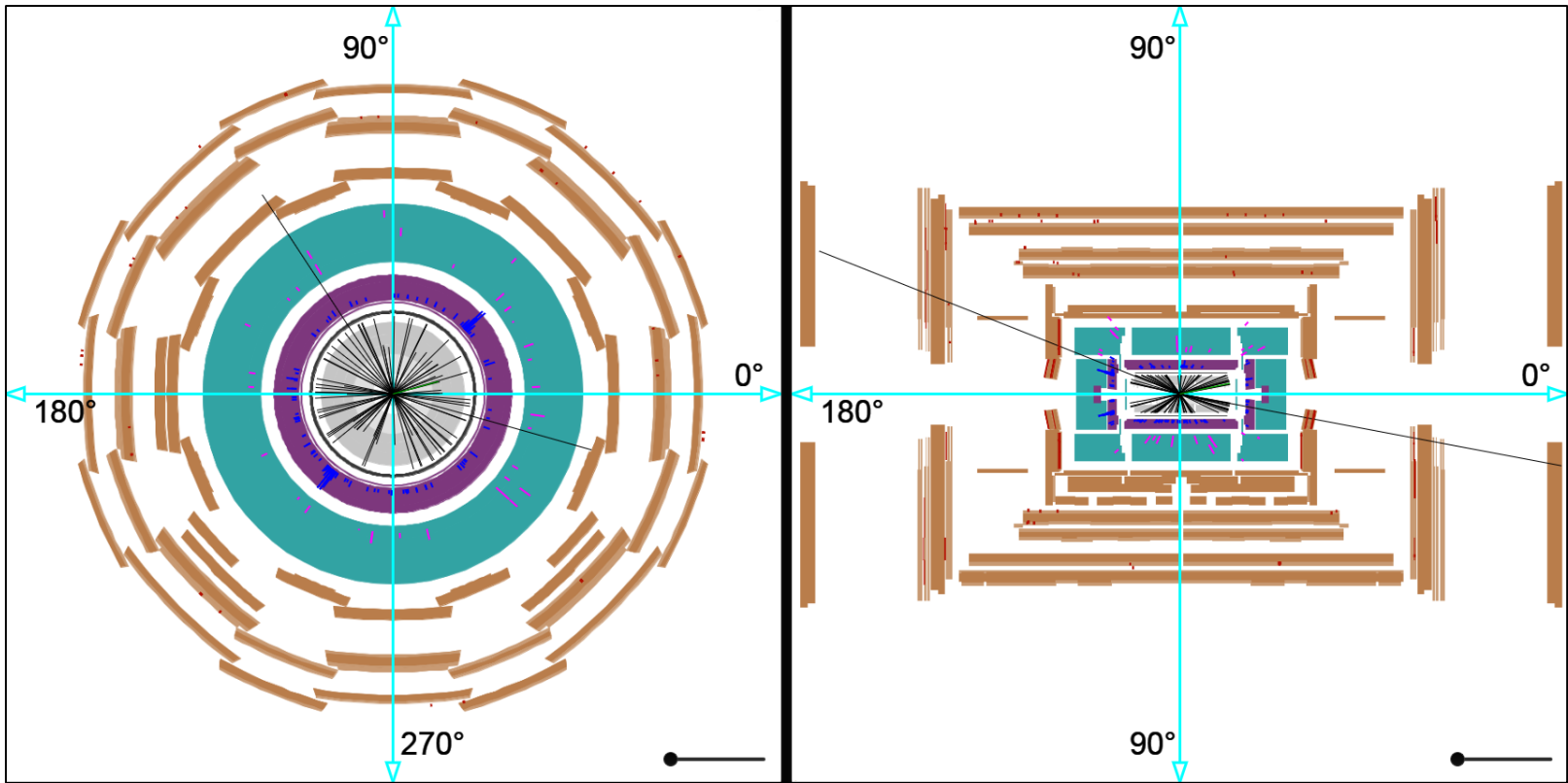

x-y view: measure ϕ

z-y view: measure θ

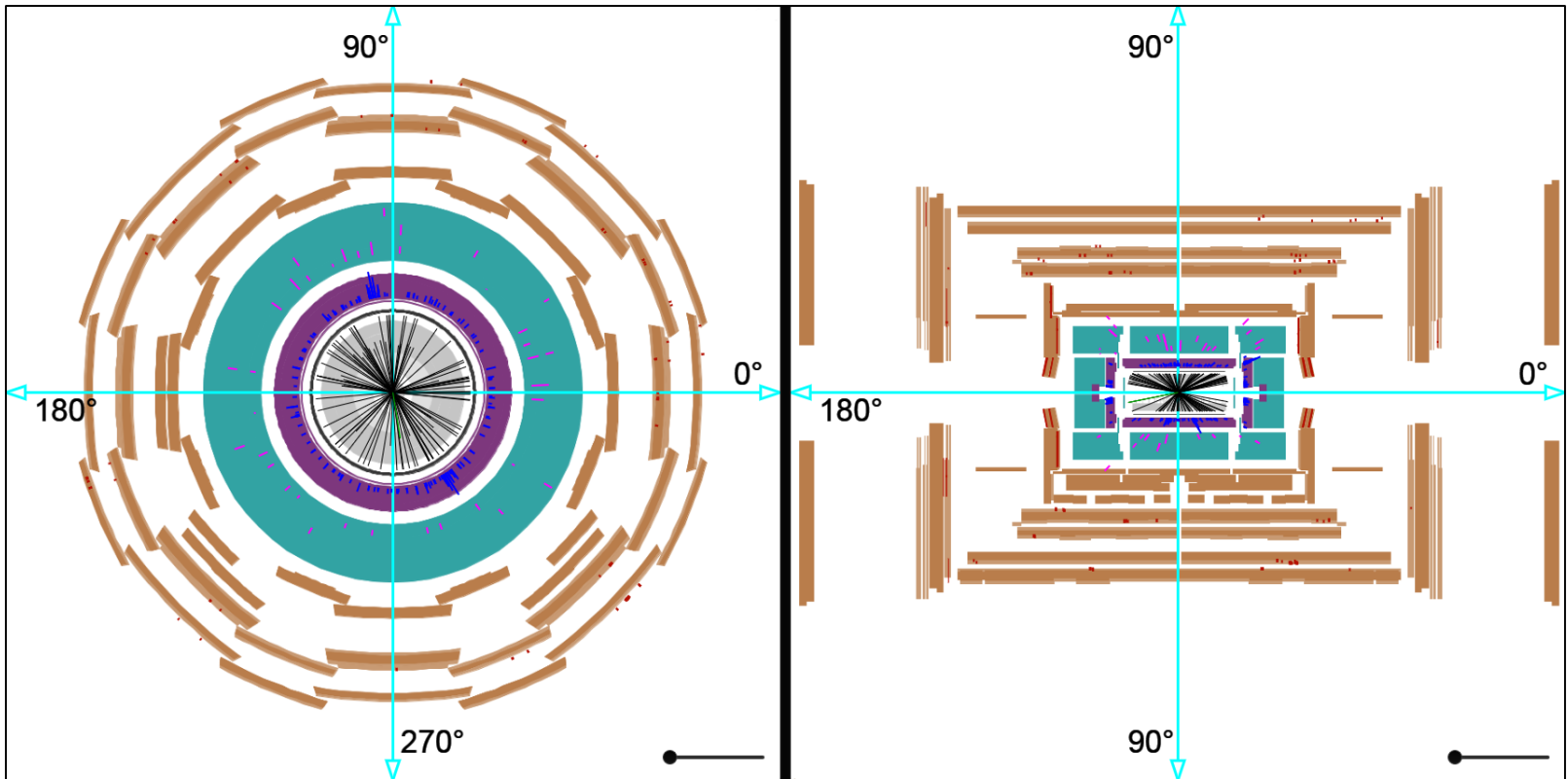

x-y view: measure ϕ

z-y view: measure θ

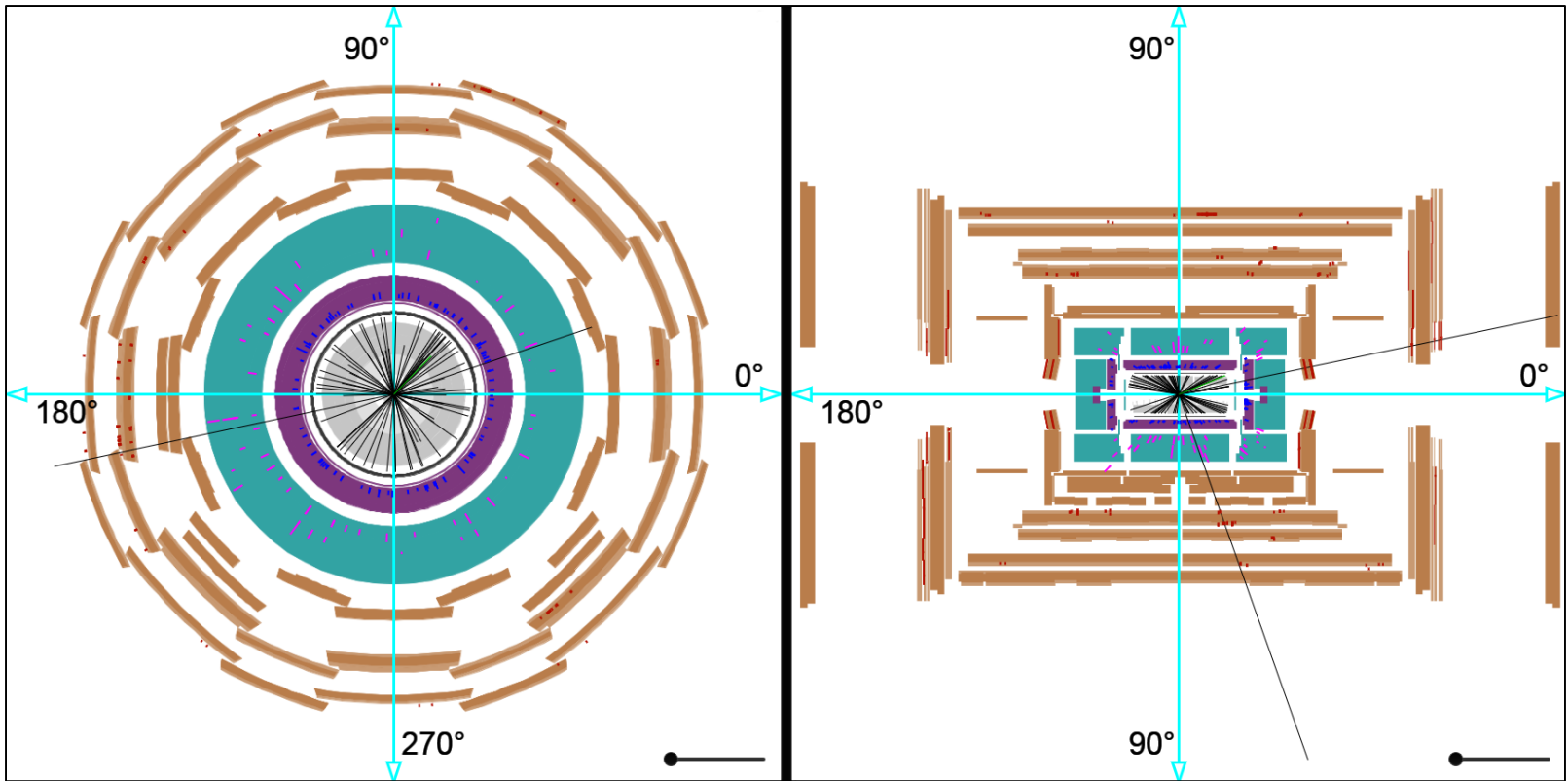

x-y view: measure ϕ

z-y view: measure θ

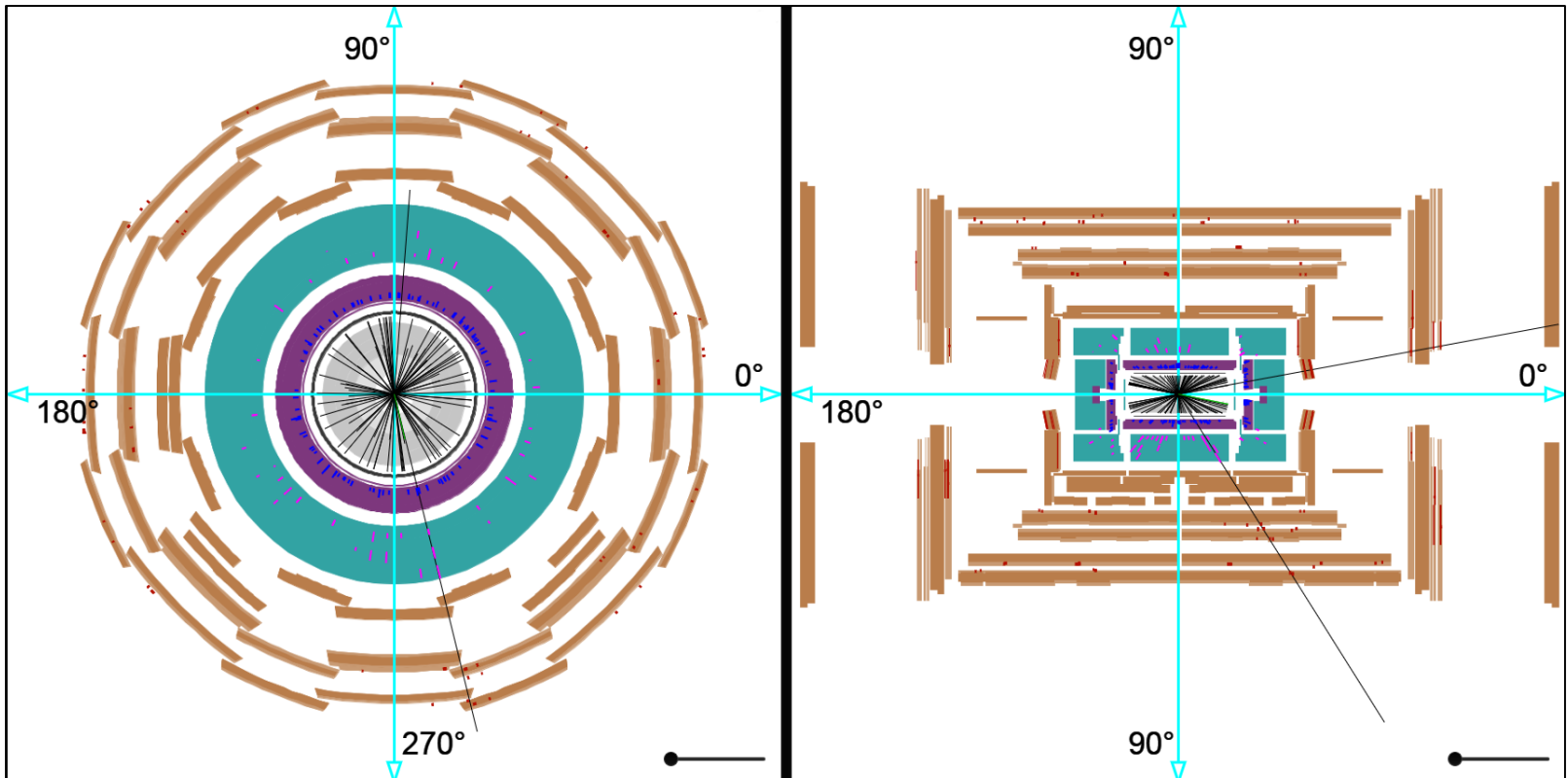

x-y view: measure ϕ

z-y view: measure θ

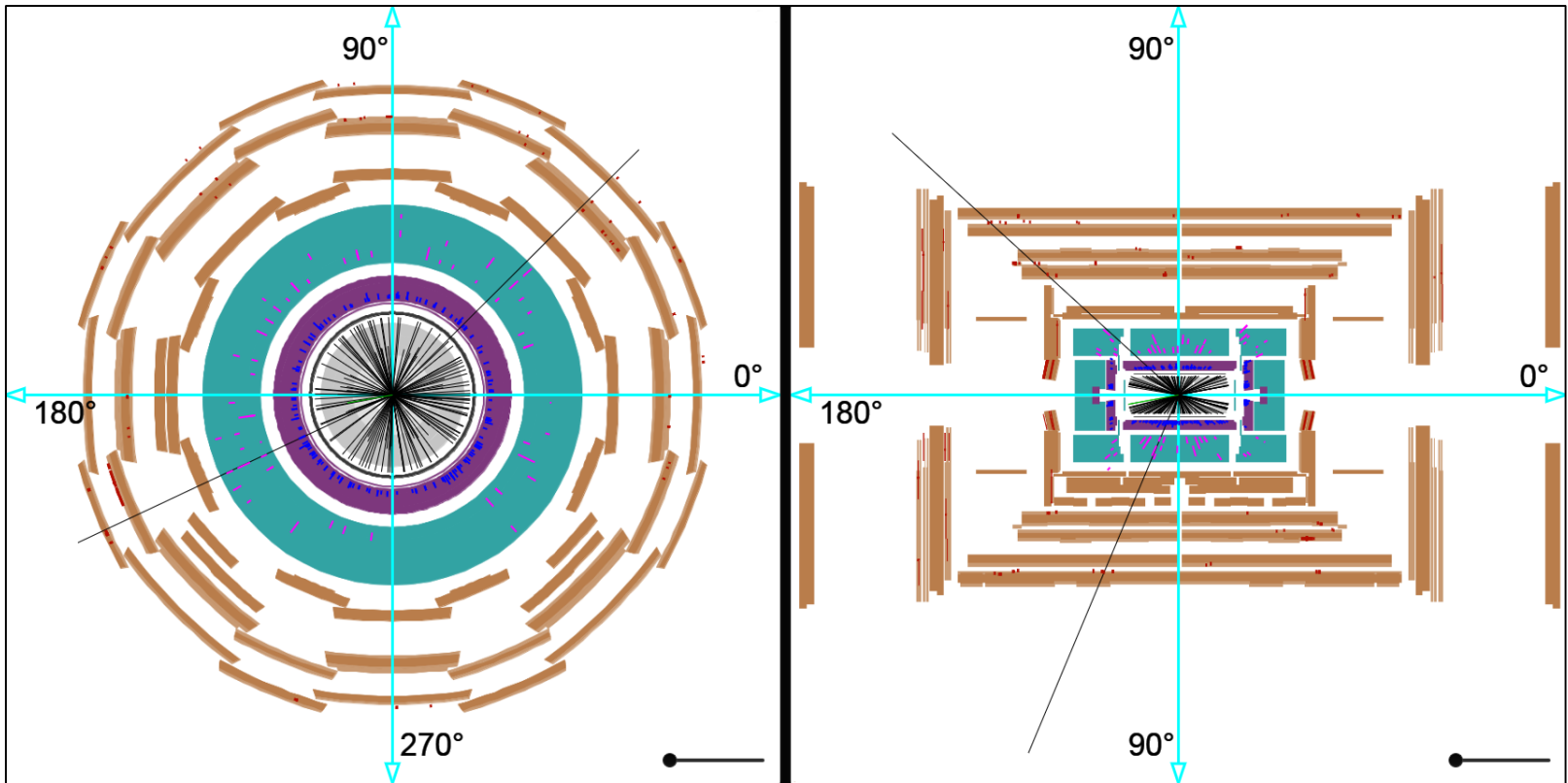

x-y view: measure ϕ

z-y view: measure θ

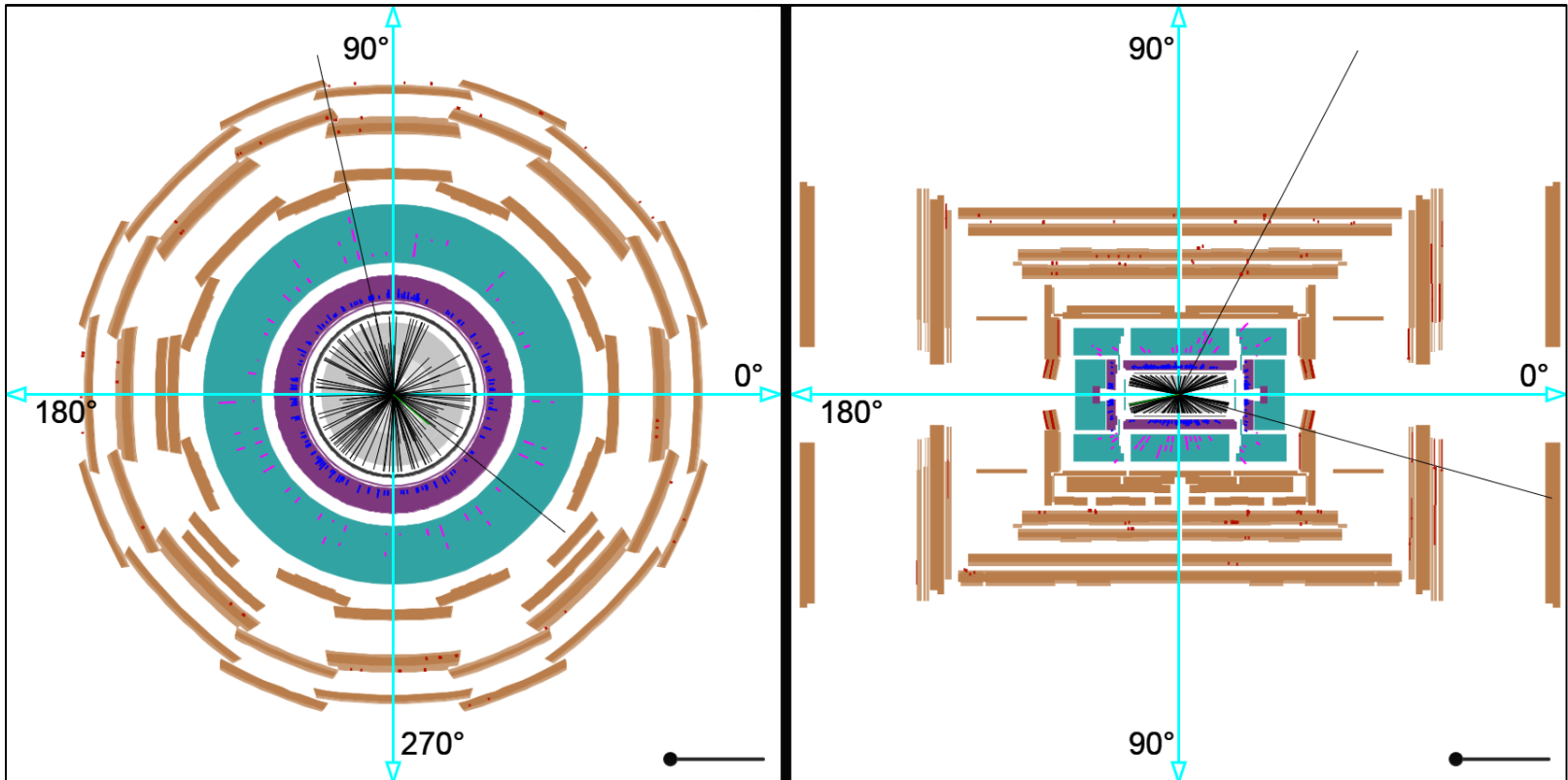

x-y view: measure ϕ

z-y view: measure θ

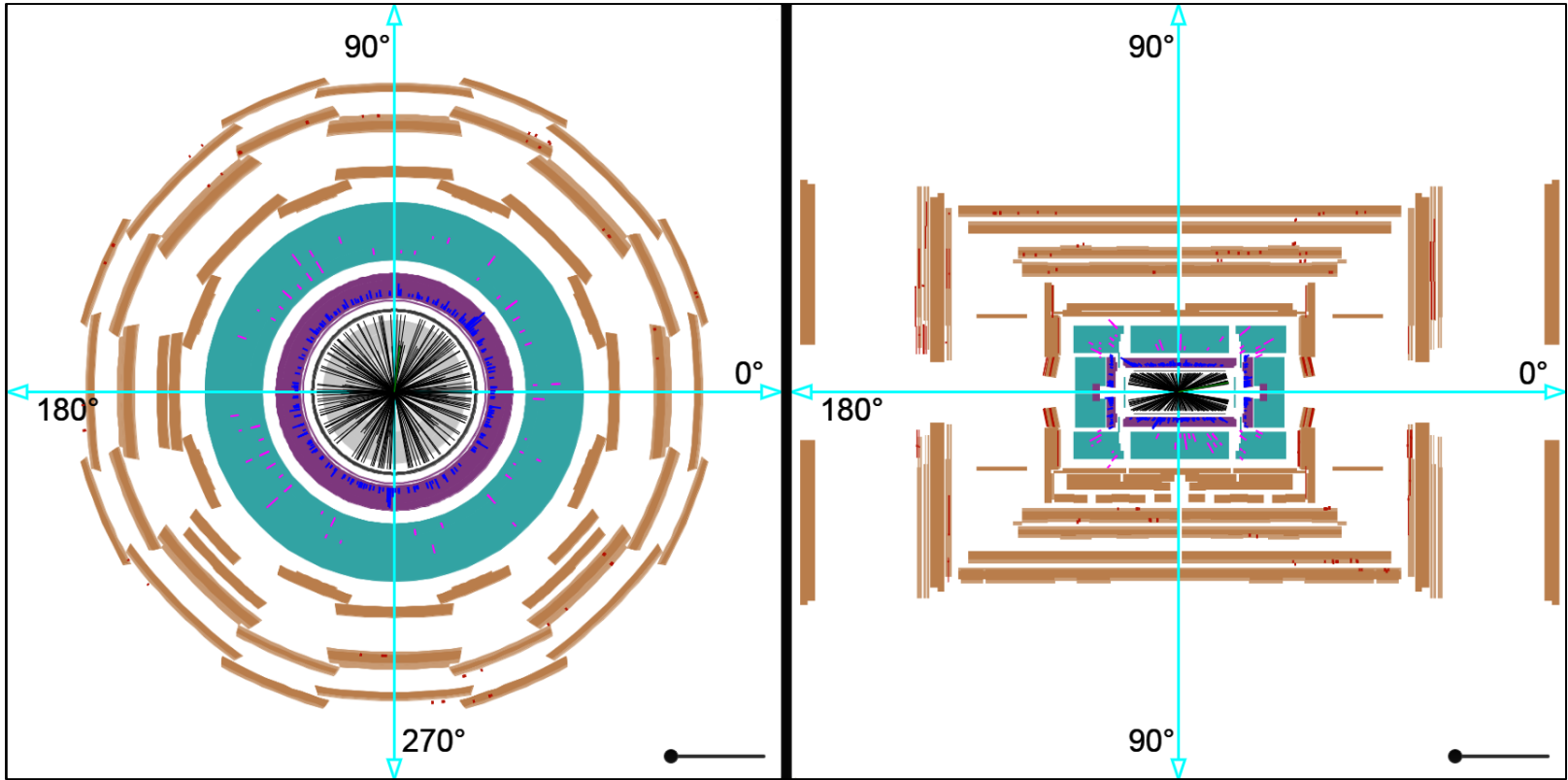

x-y view: measure ϕ

z-y view: measure θ

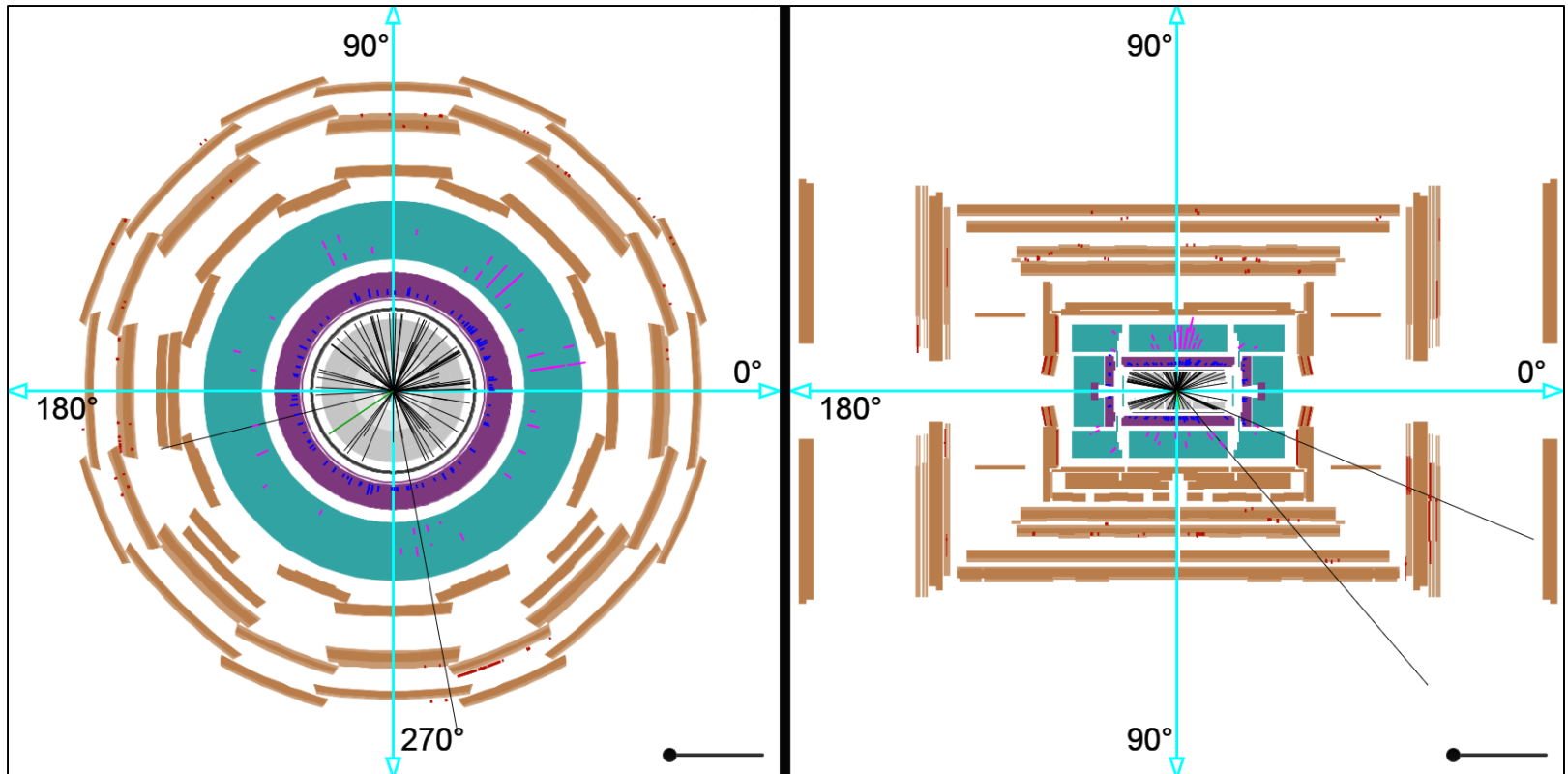

x-y view: measure ϕ

z-y view: measure θ

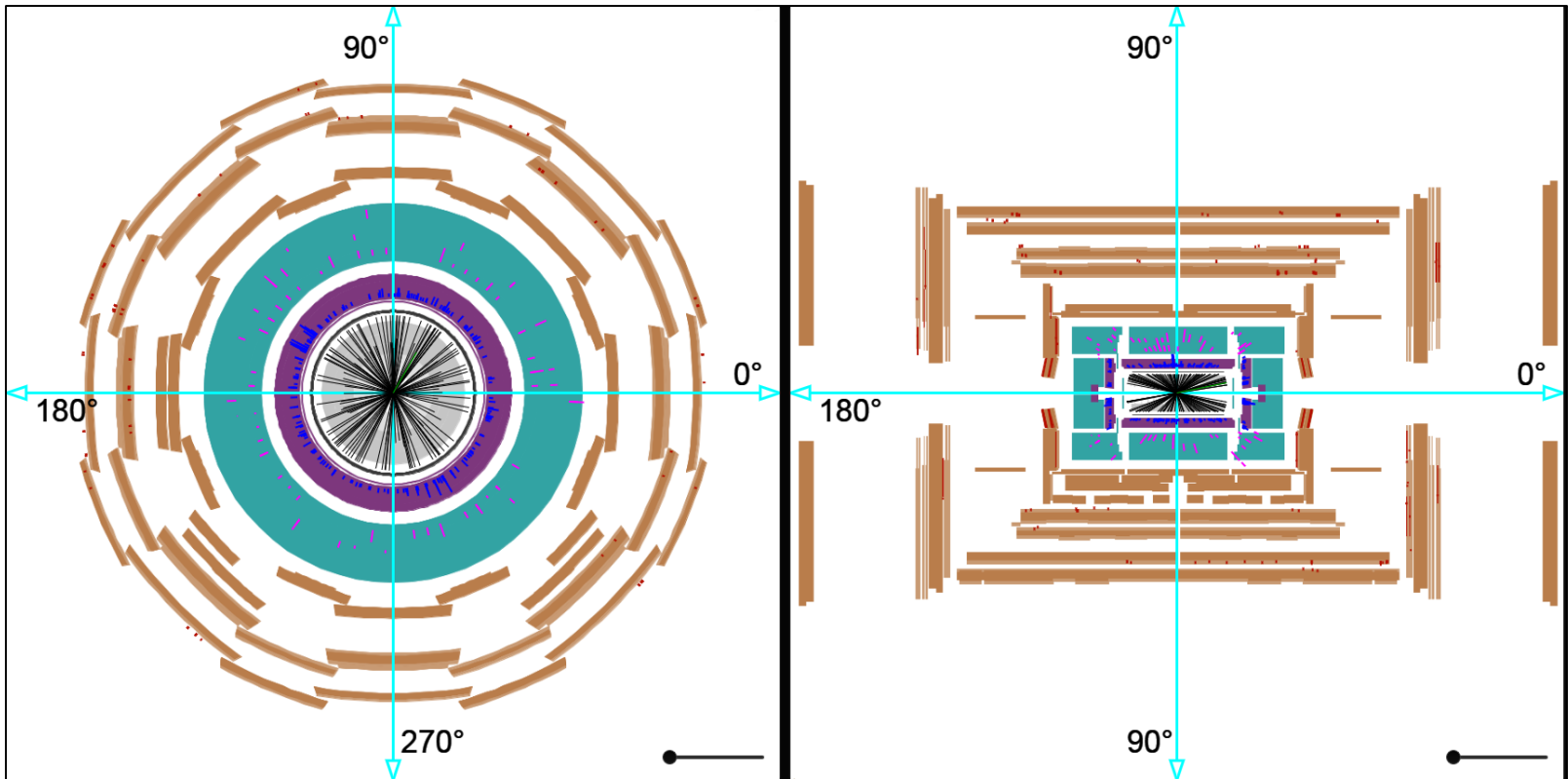

x-y view: measure ϕ

z-y view: measure θ

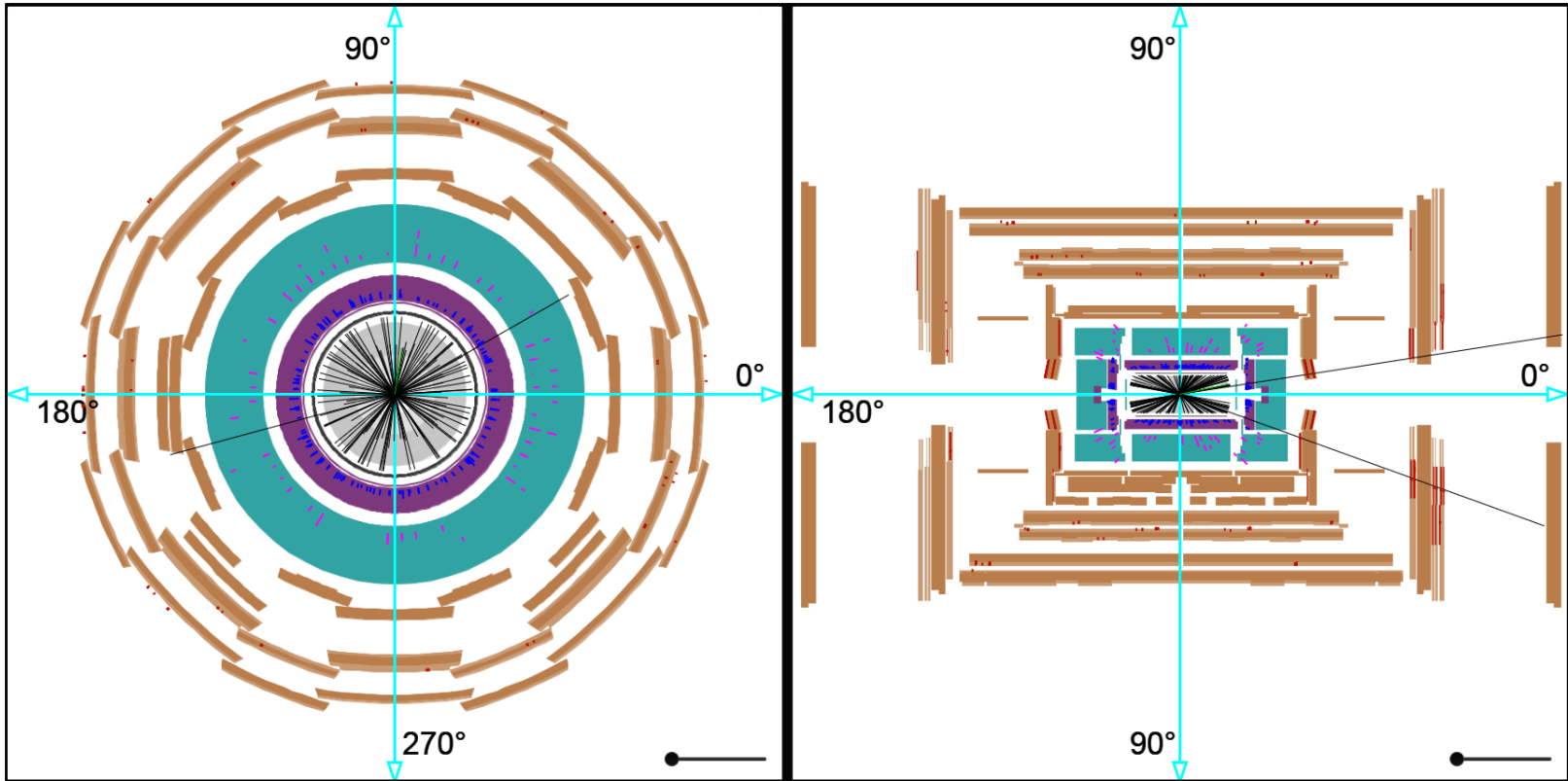

x-y view: measure ϕ

z-y view: measure θ

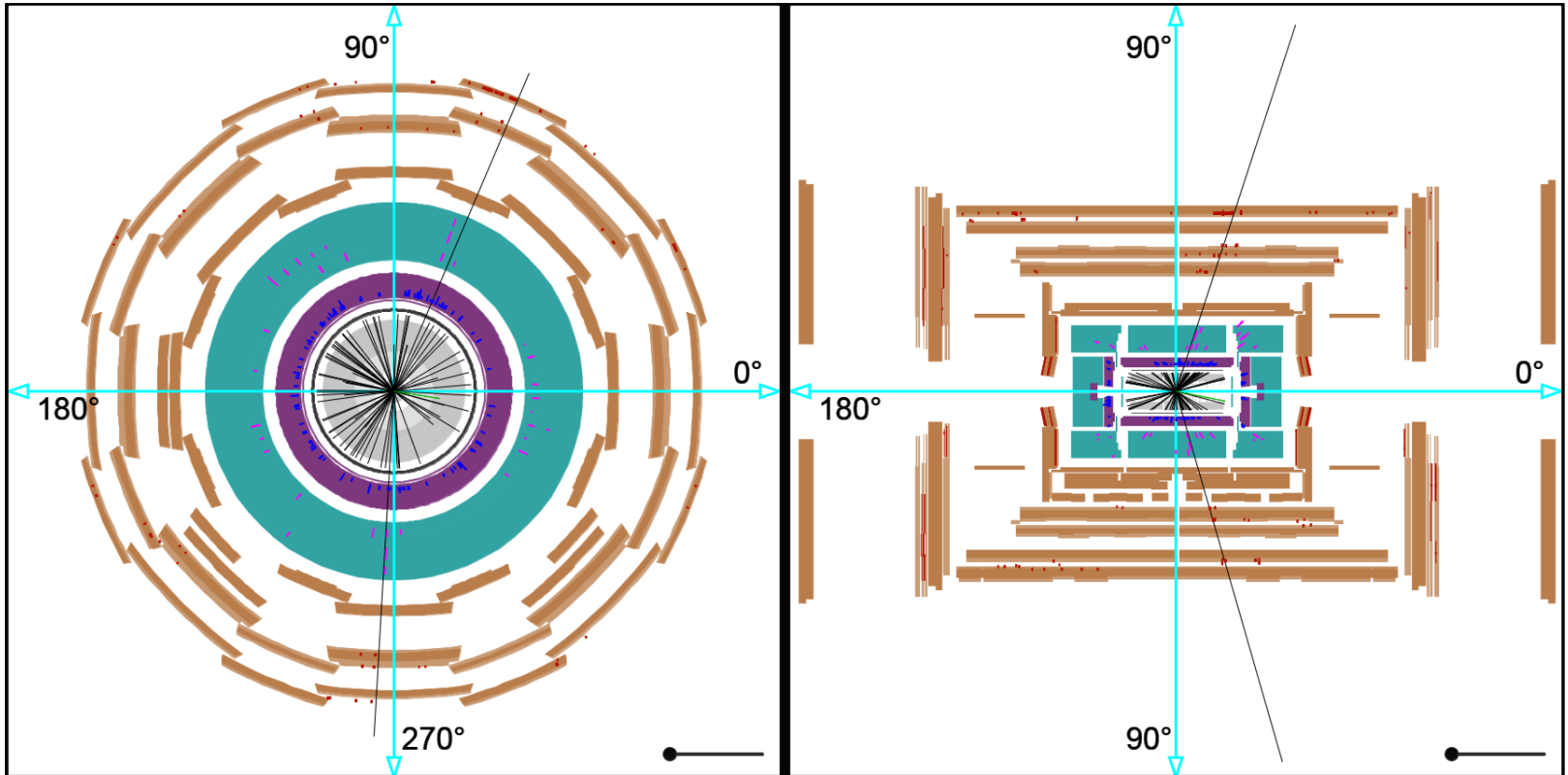

x-y view: measure ϕ

z-y view: measure θ

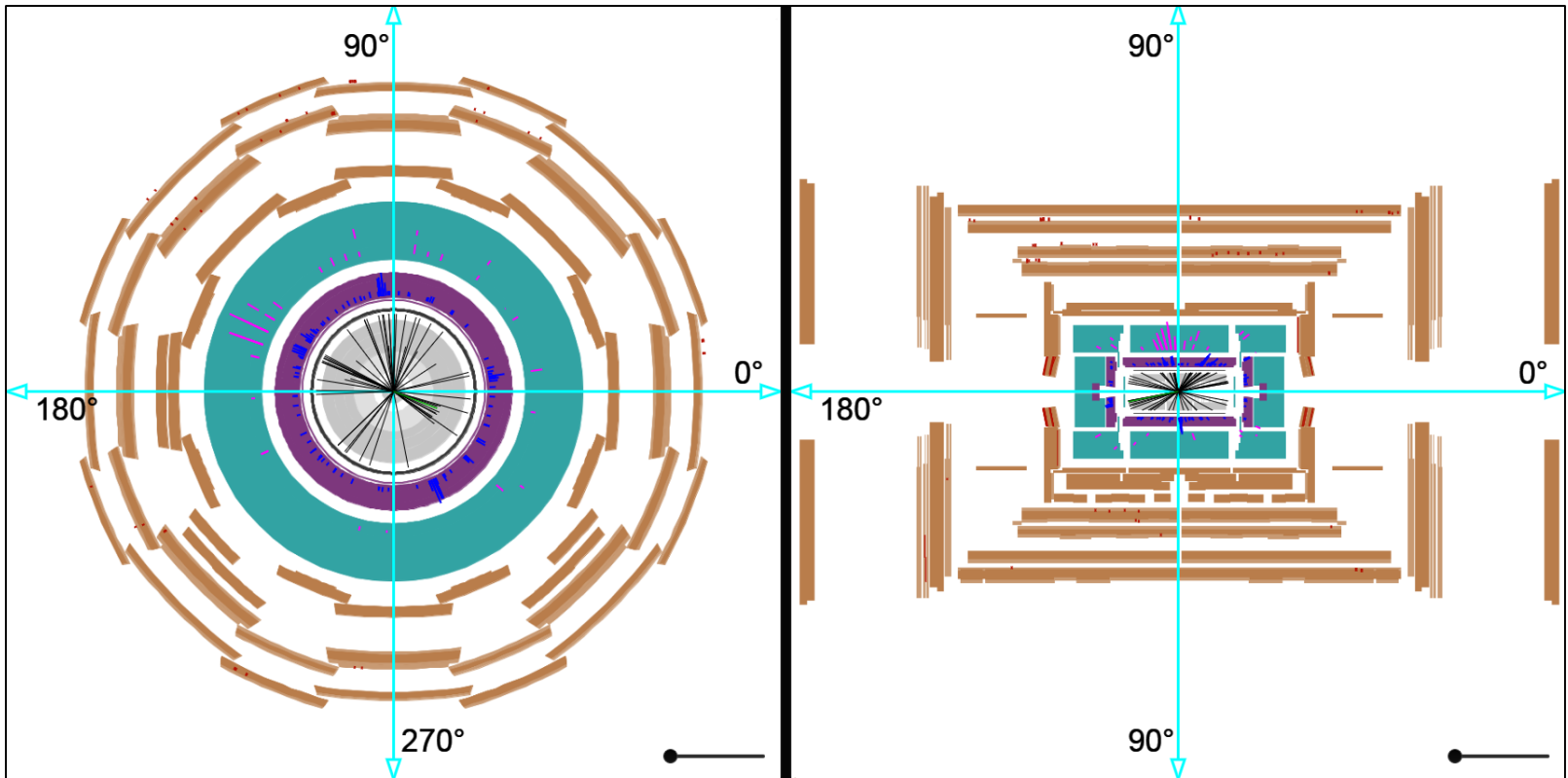

x-y view: measure ϕ

z-y view: measure θ

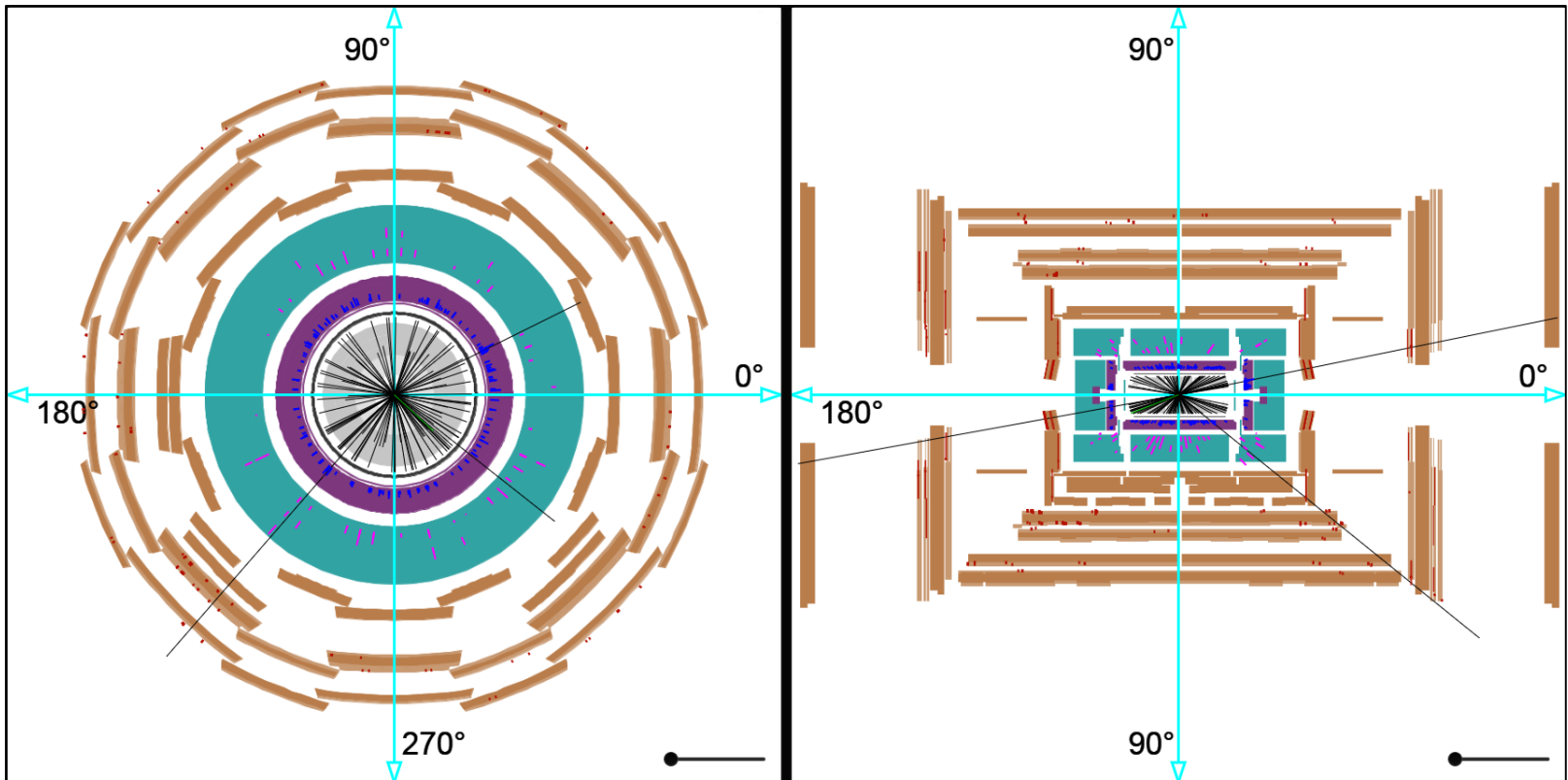

x-y view: measure ϕ

z-y view: measure θ

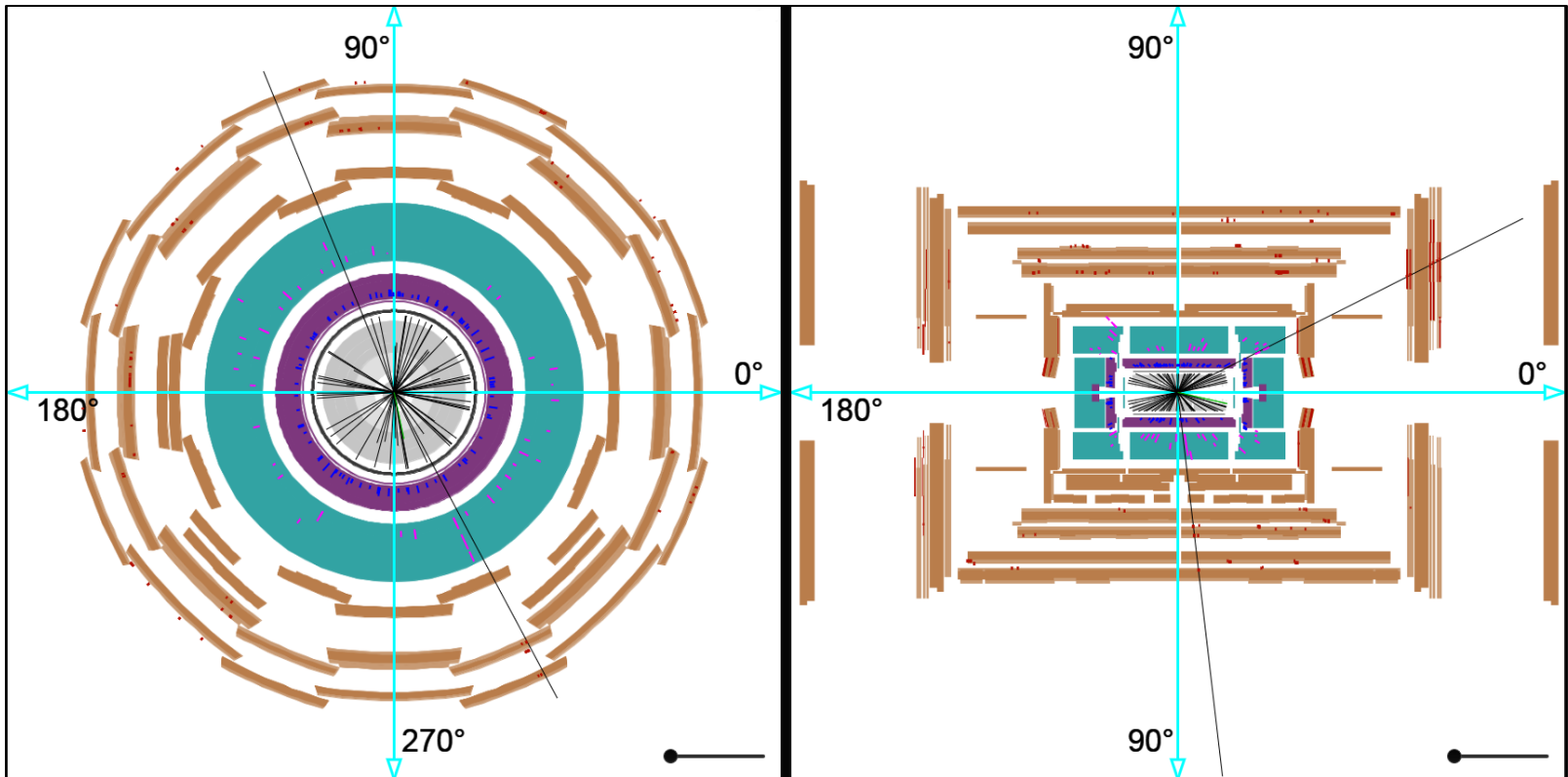

x-y view: measure ϕ

z-y view: measure θ

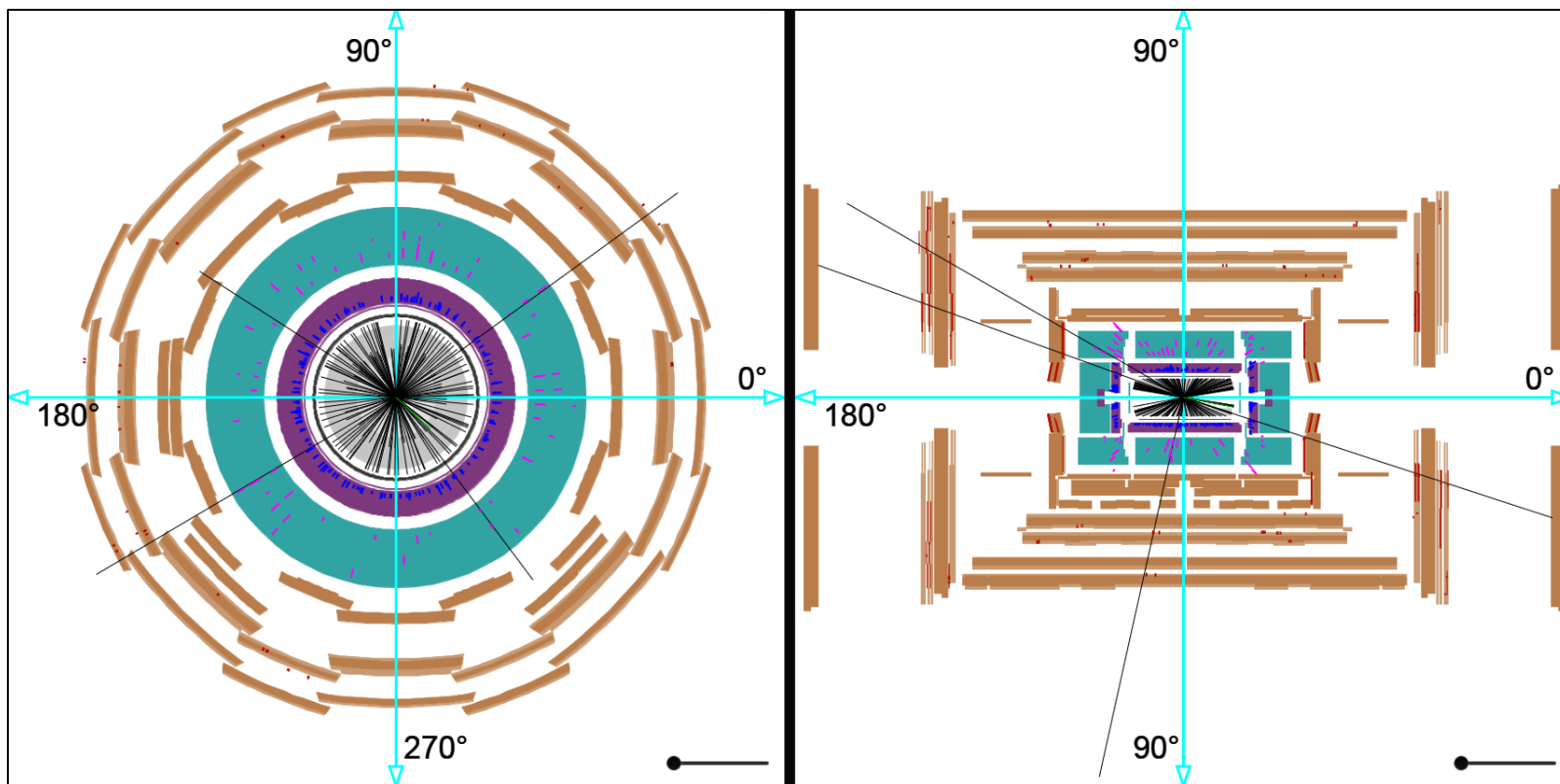

x-y view: measure ϕ

z-y view: measure θ

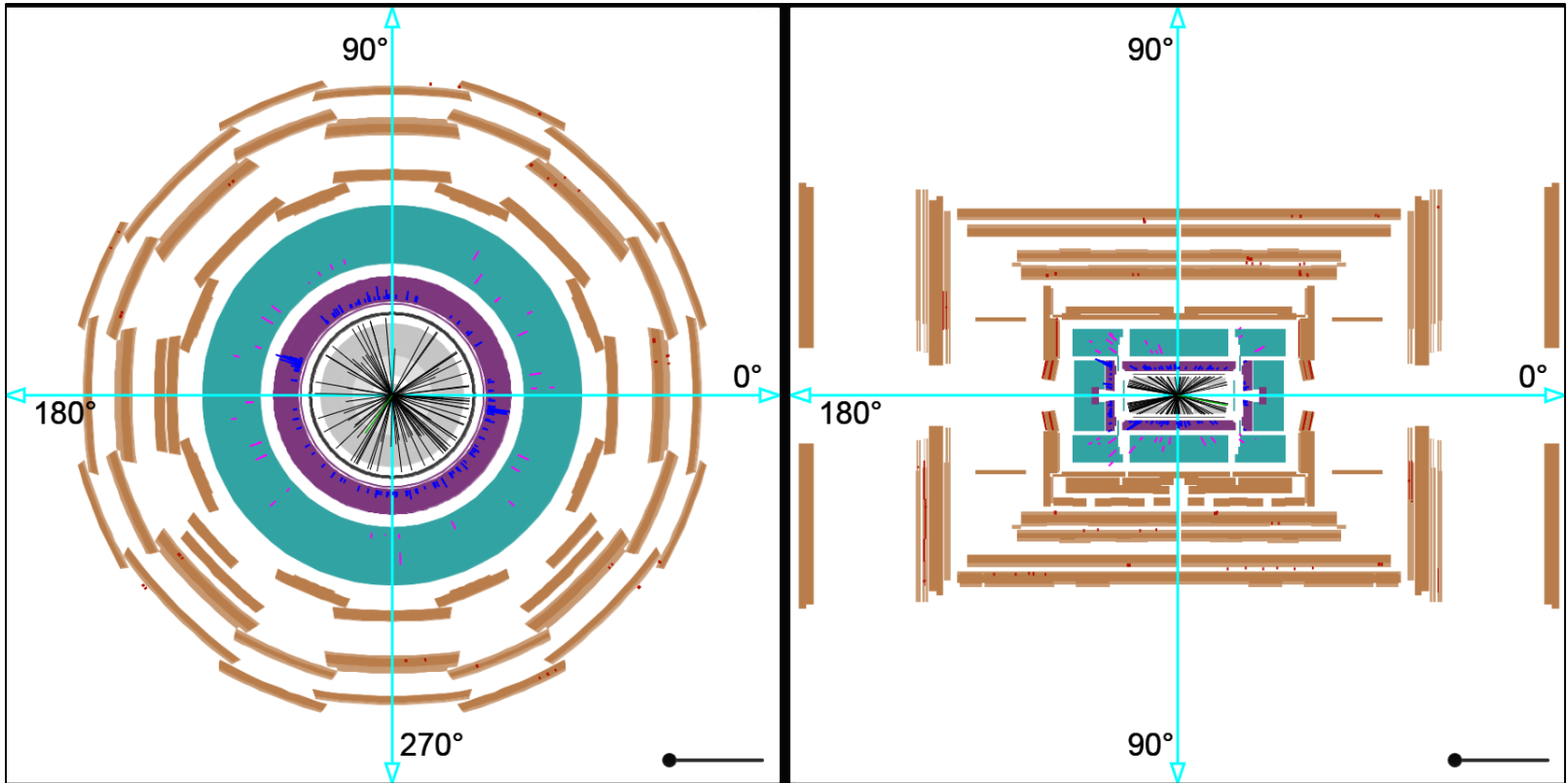

x-y view: measure ϕ

z-y view: measure θ

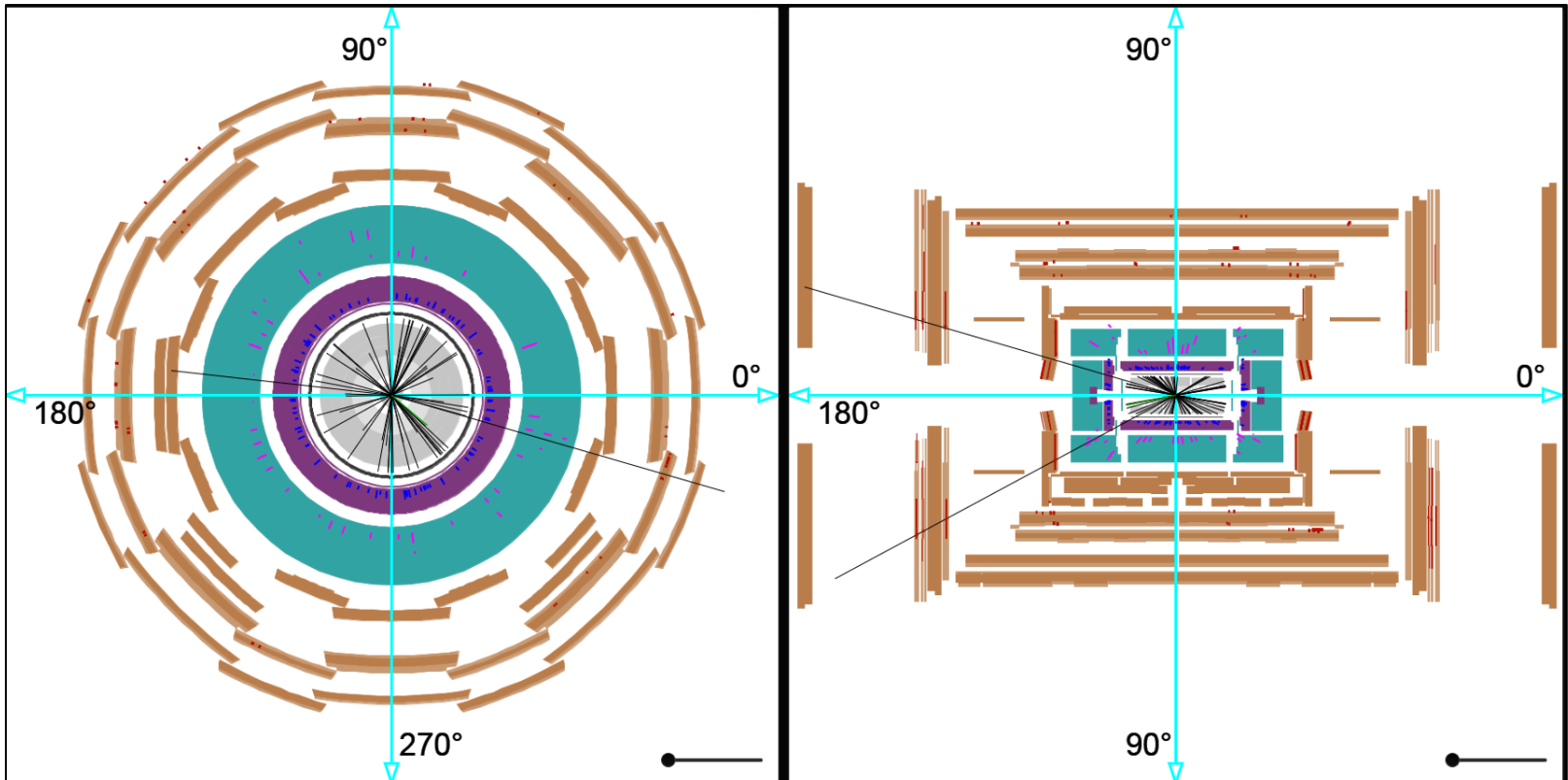

x-y view: measure ϕ

z-y view: measure θ

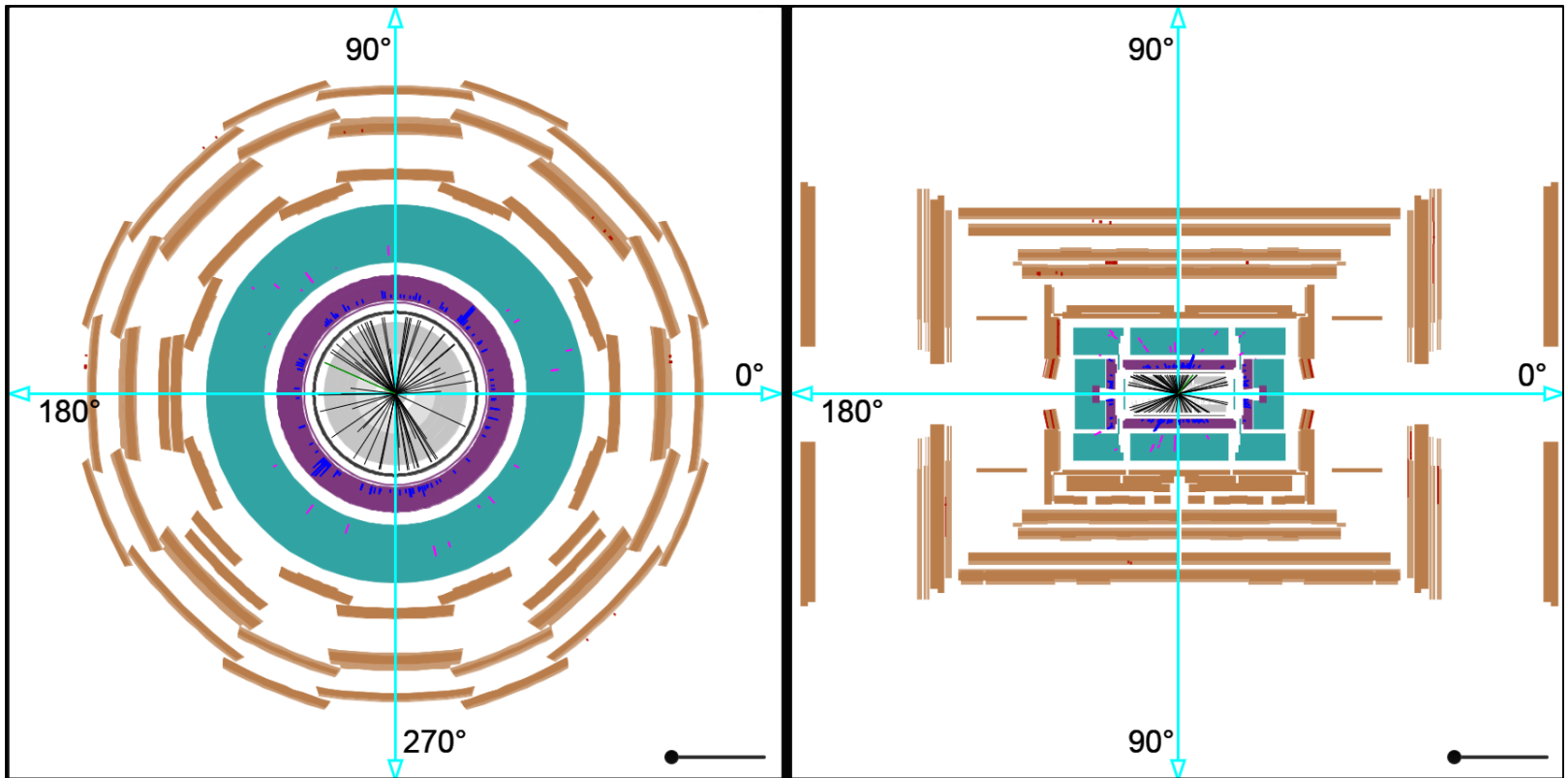

x-y view: measure ϕ

z-y view: measure θ

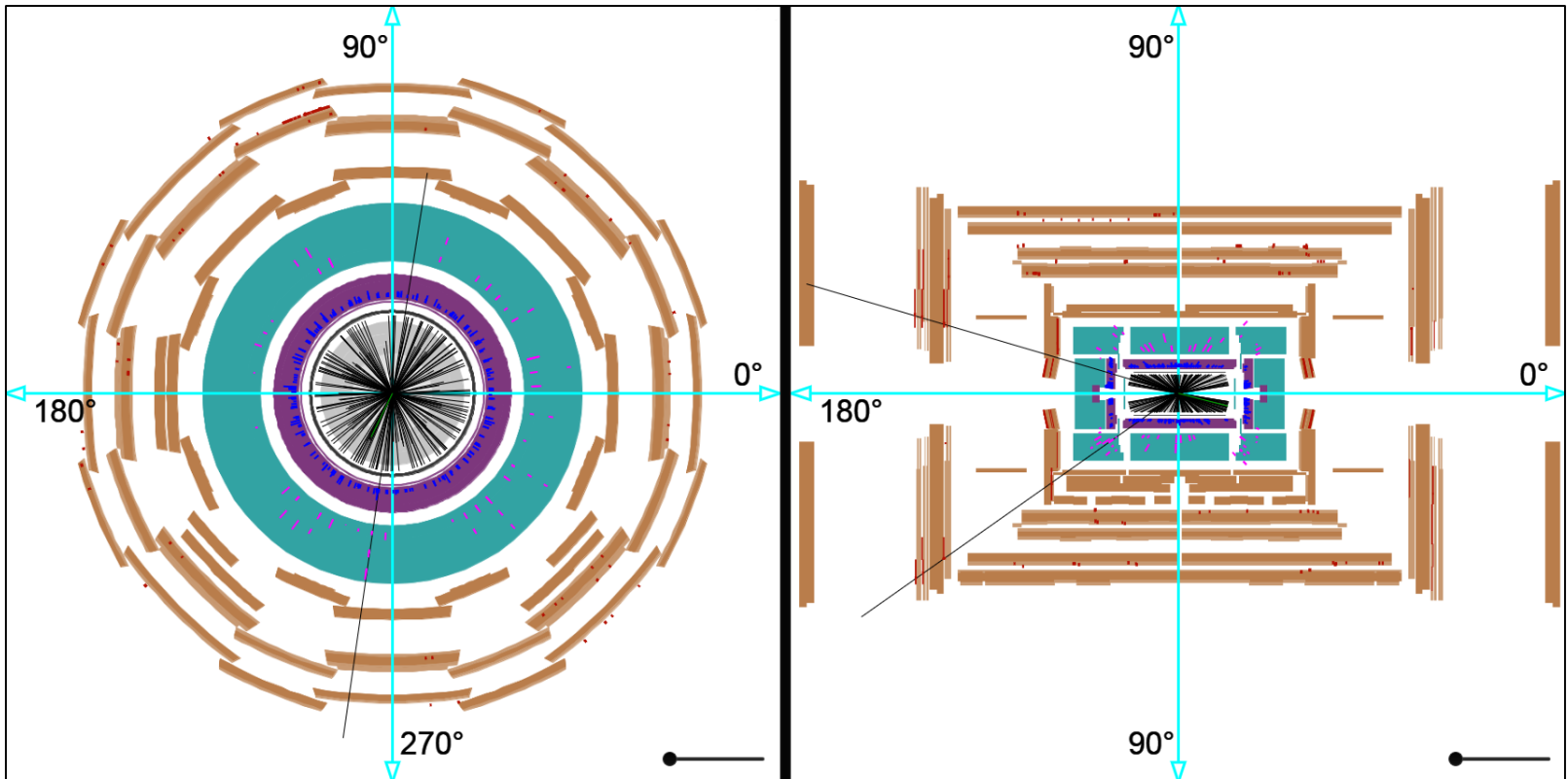

x-y view: measure ϕ

z-y view: measure θ

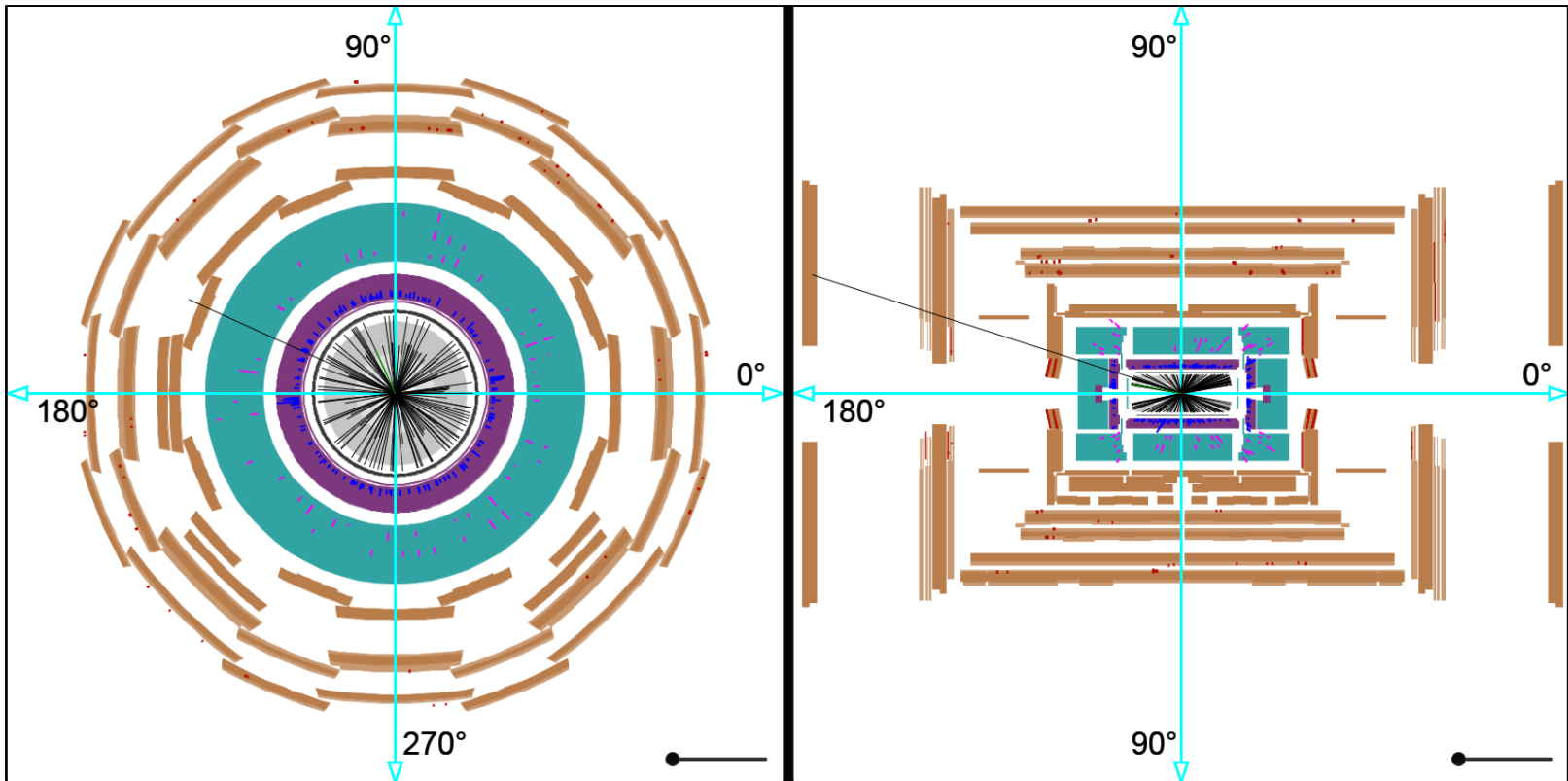

x-y view: measure ϕ

z-y view: measure θ

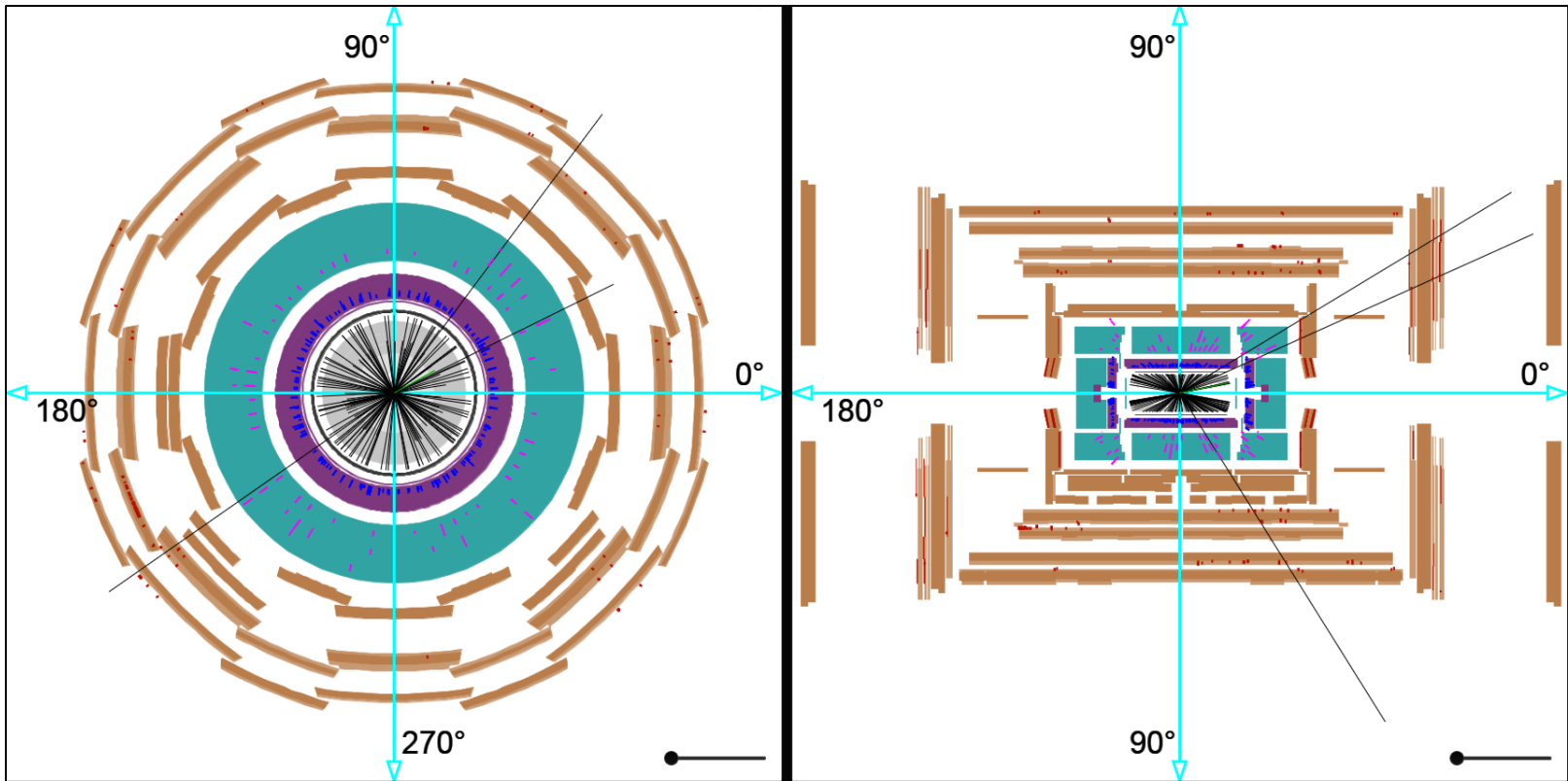

x-y view: measure ϕ

z-y view: measure θ

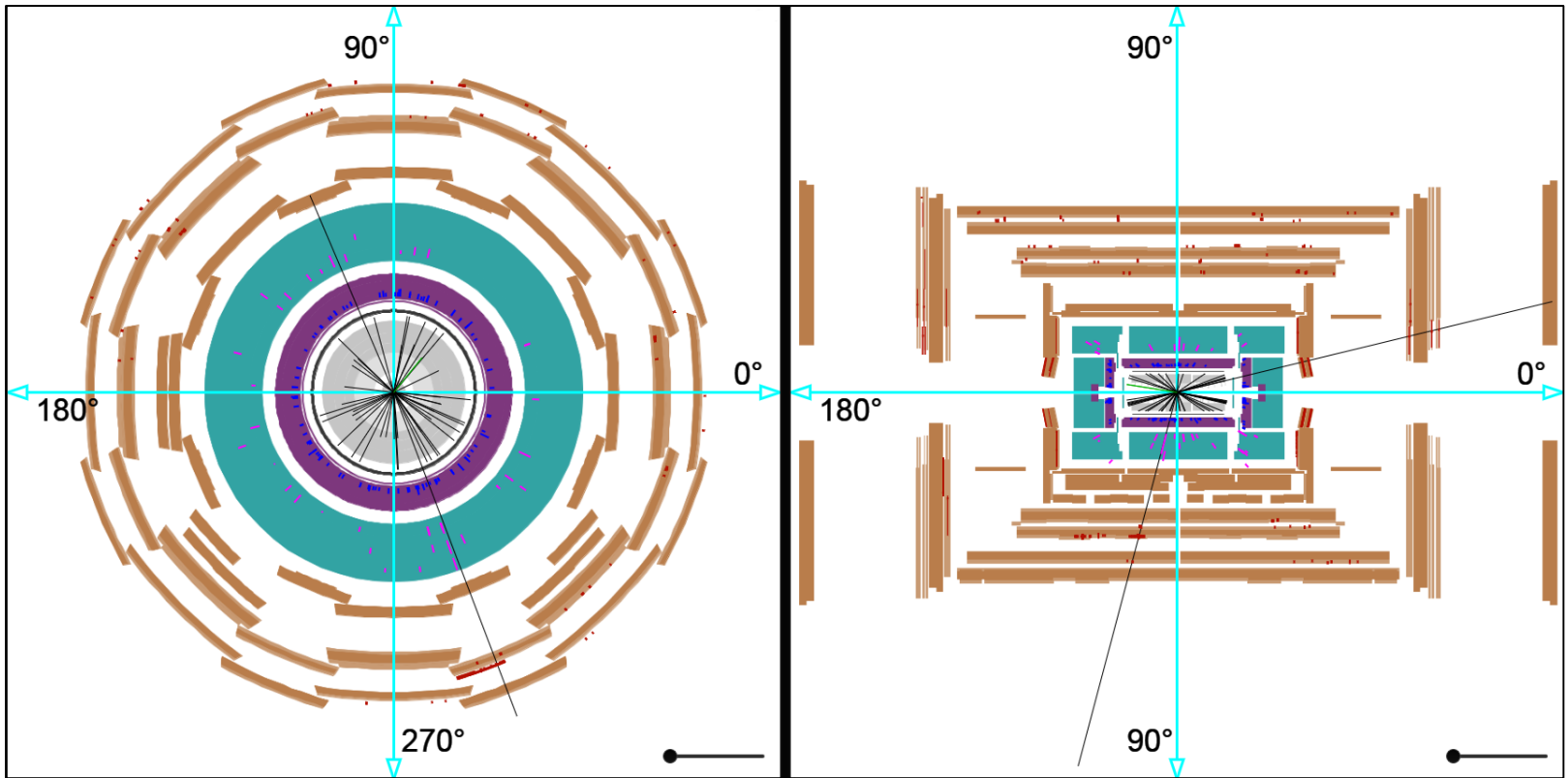

x-y view: measure ϕ

z-y view: measure θ

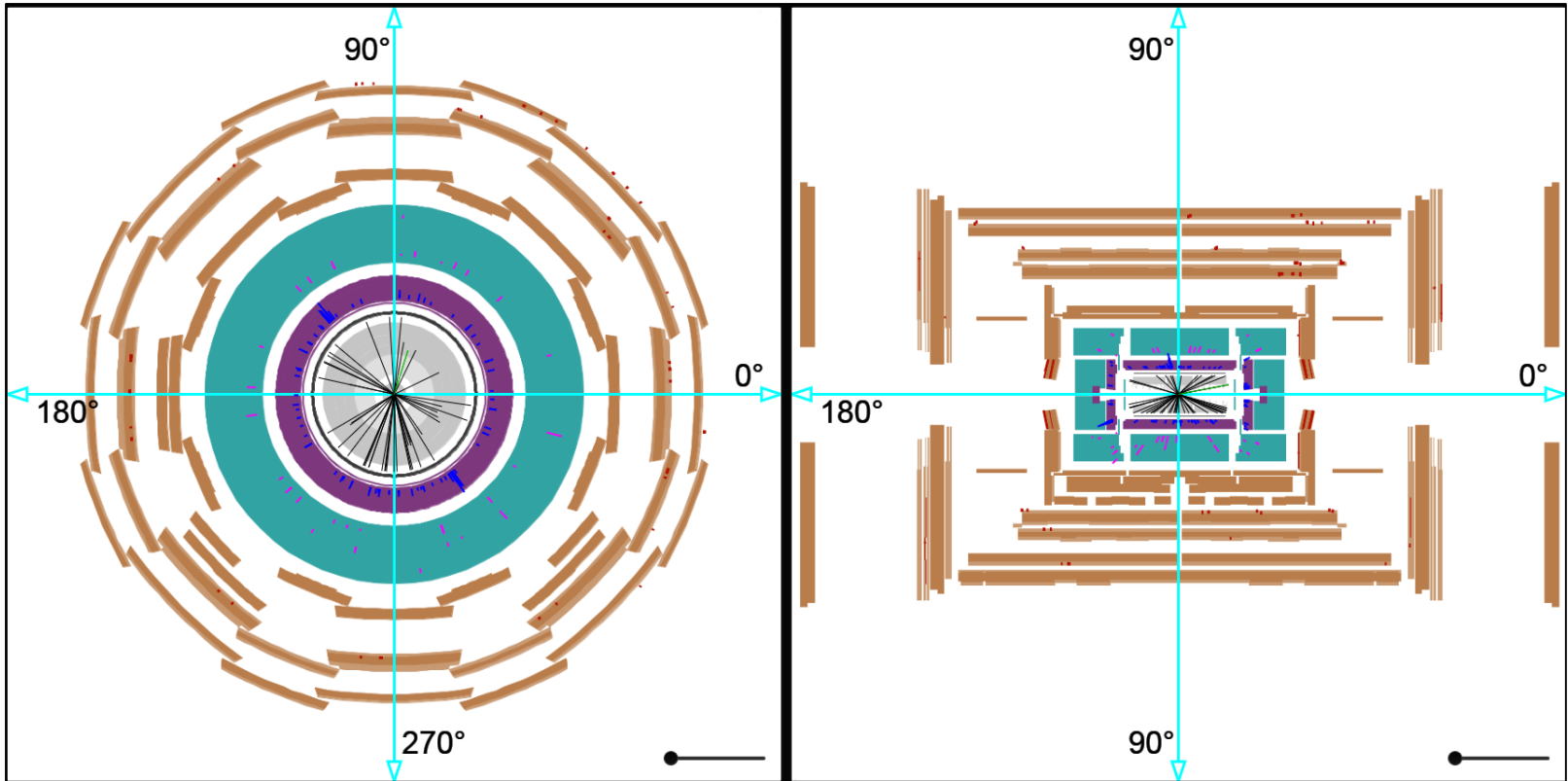

x-y view: measure ϕ

z-y view: measure θ

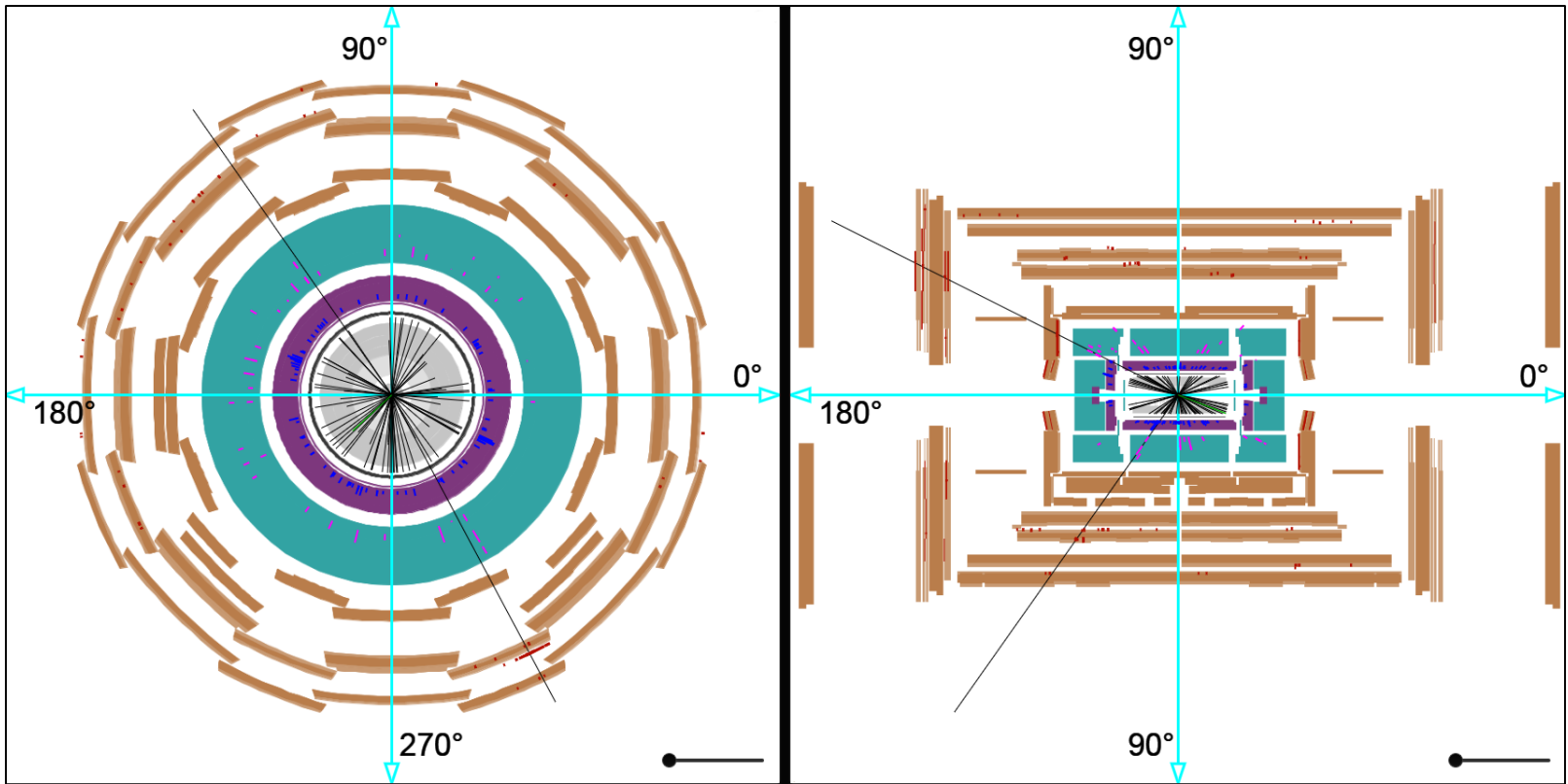

x-y view: measure ϕ

z-y view: measure θ

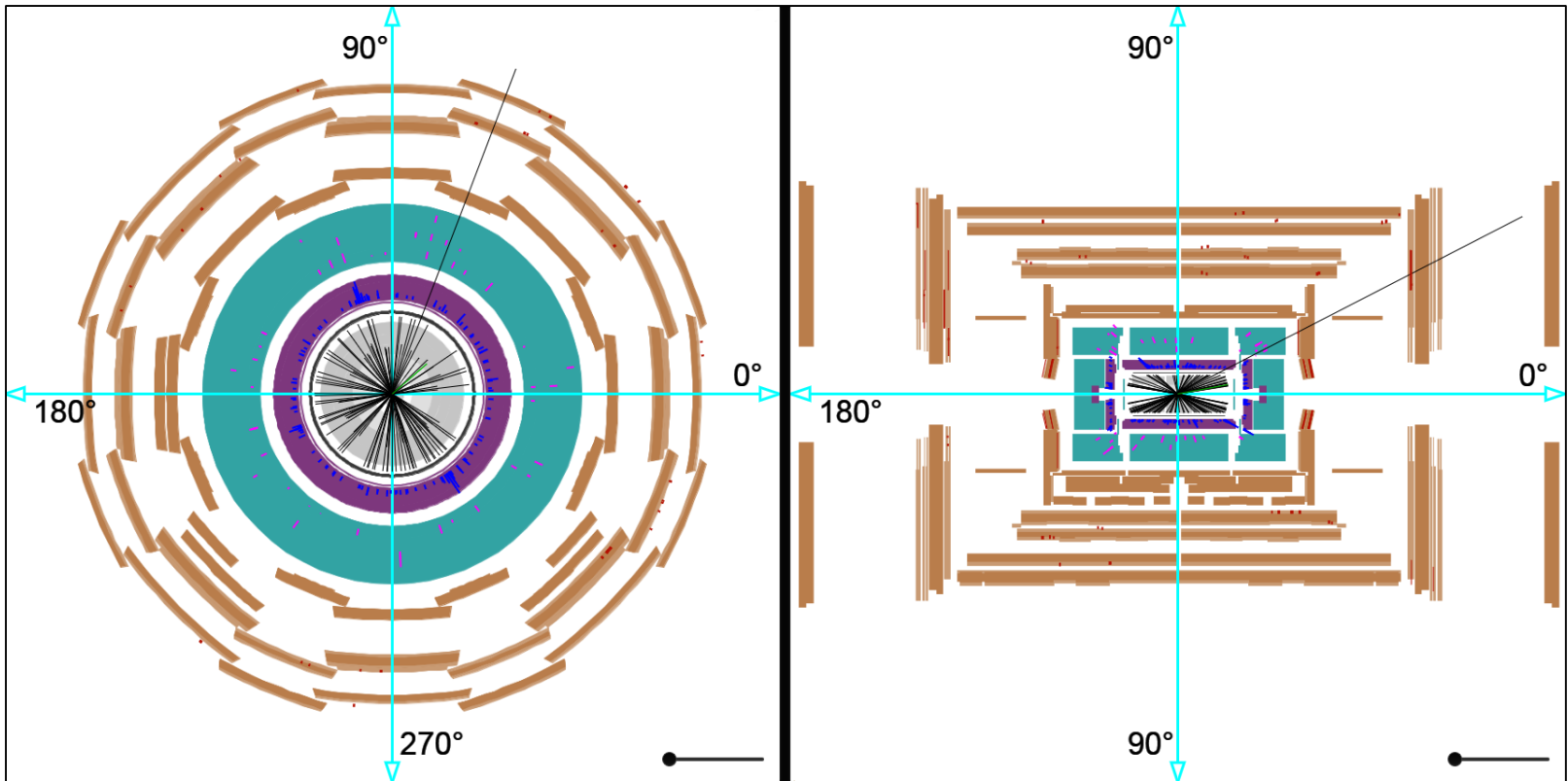

x-y view: measure ϕ

z-y view: measure θ

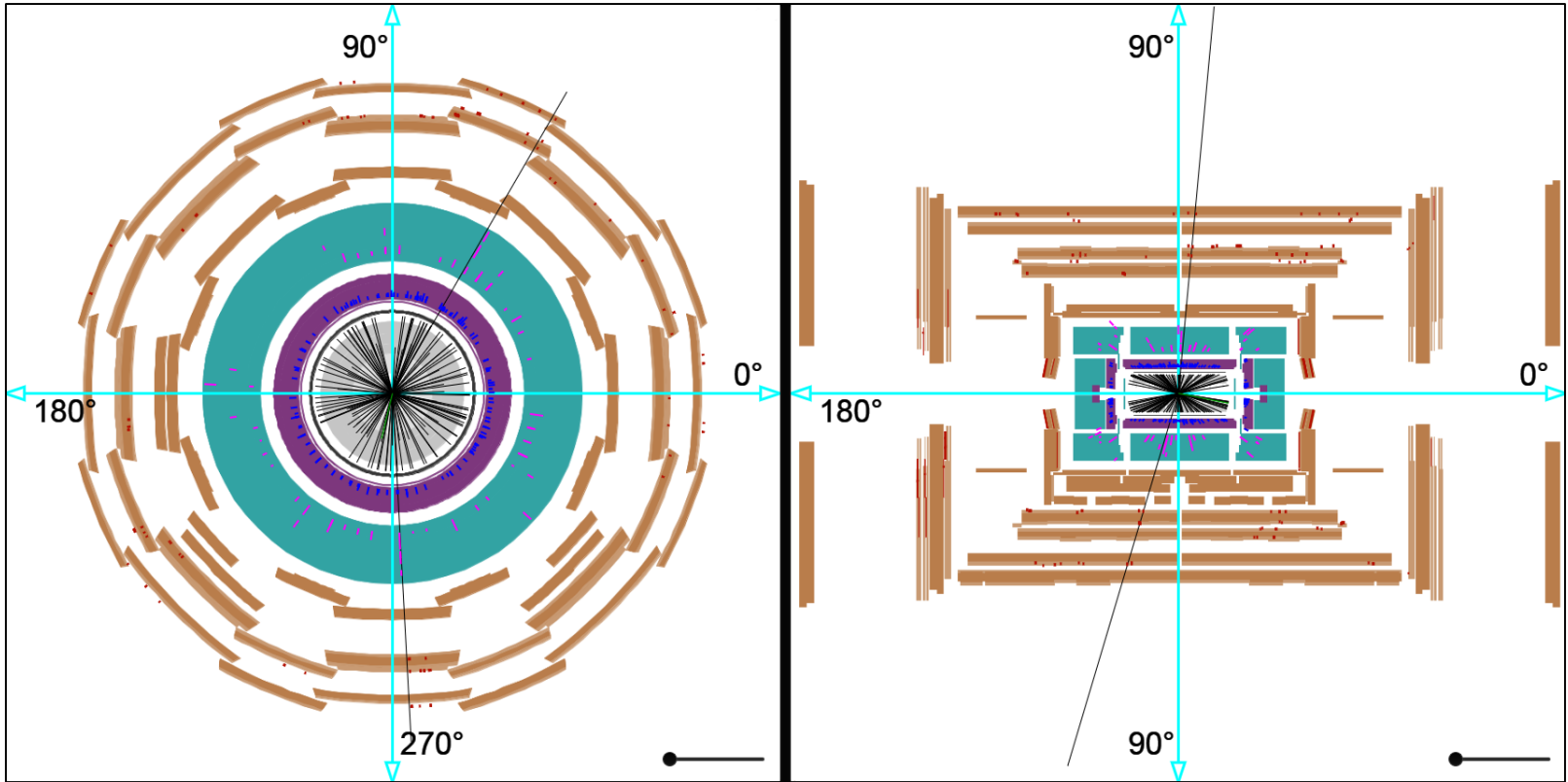

x-y view: measure ϕ

z-y view: measure θ

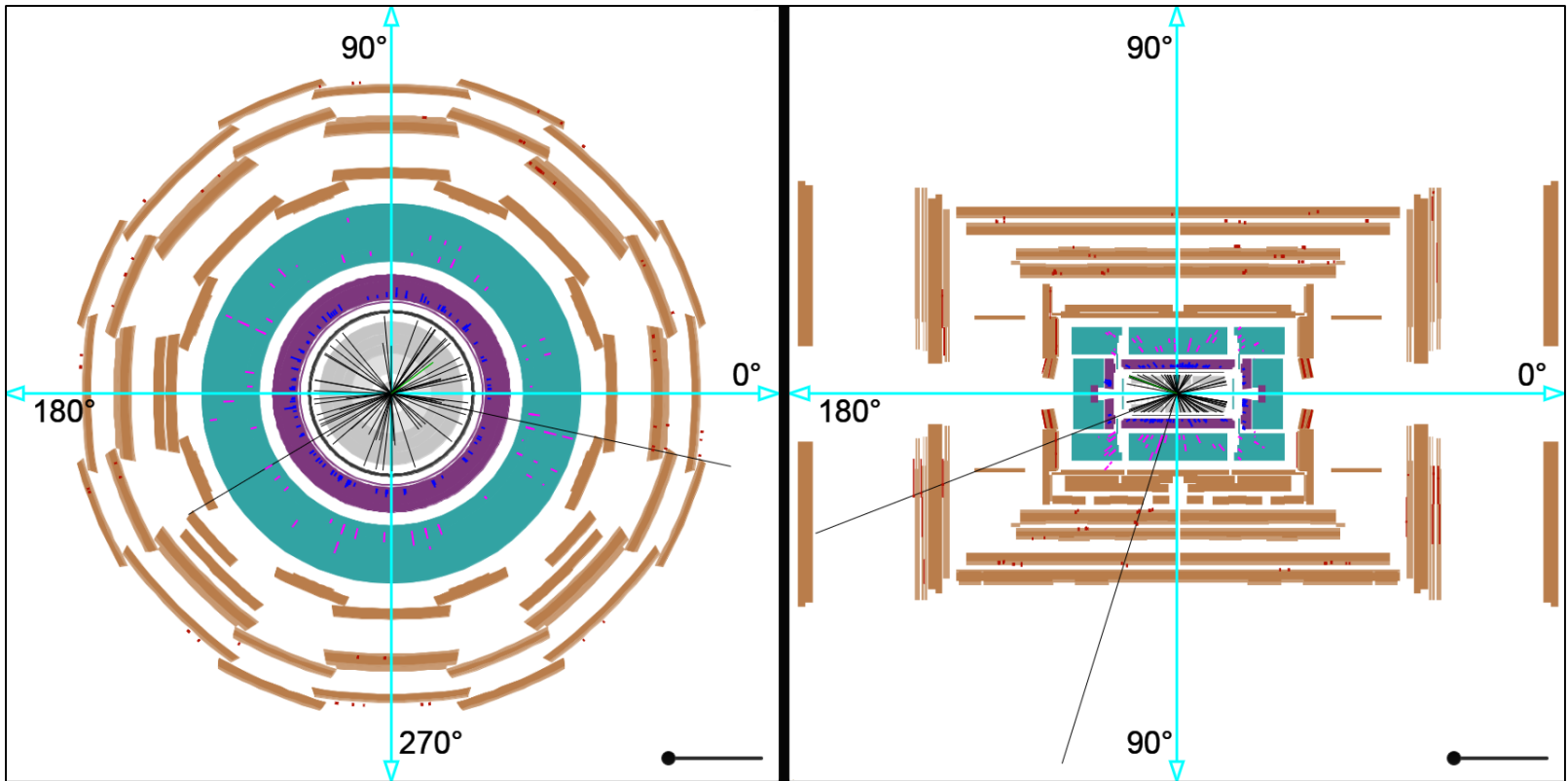

x-y view: measure ϕ

z-y view: measure θ

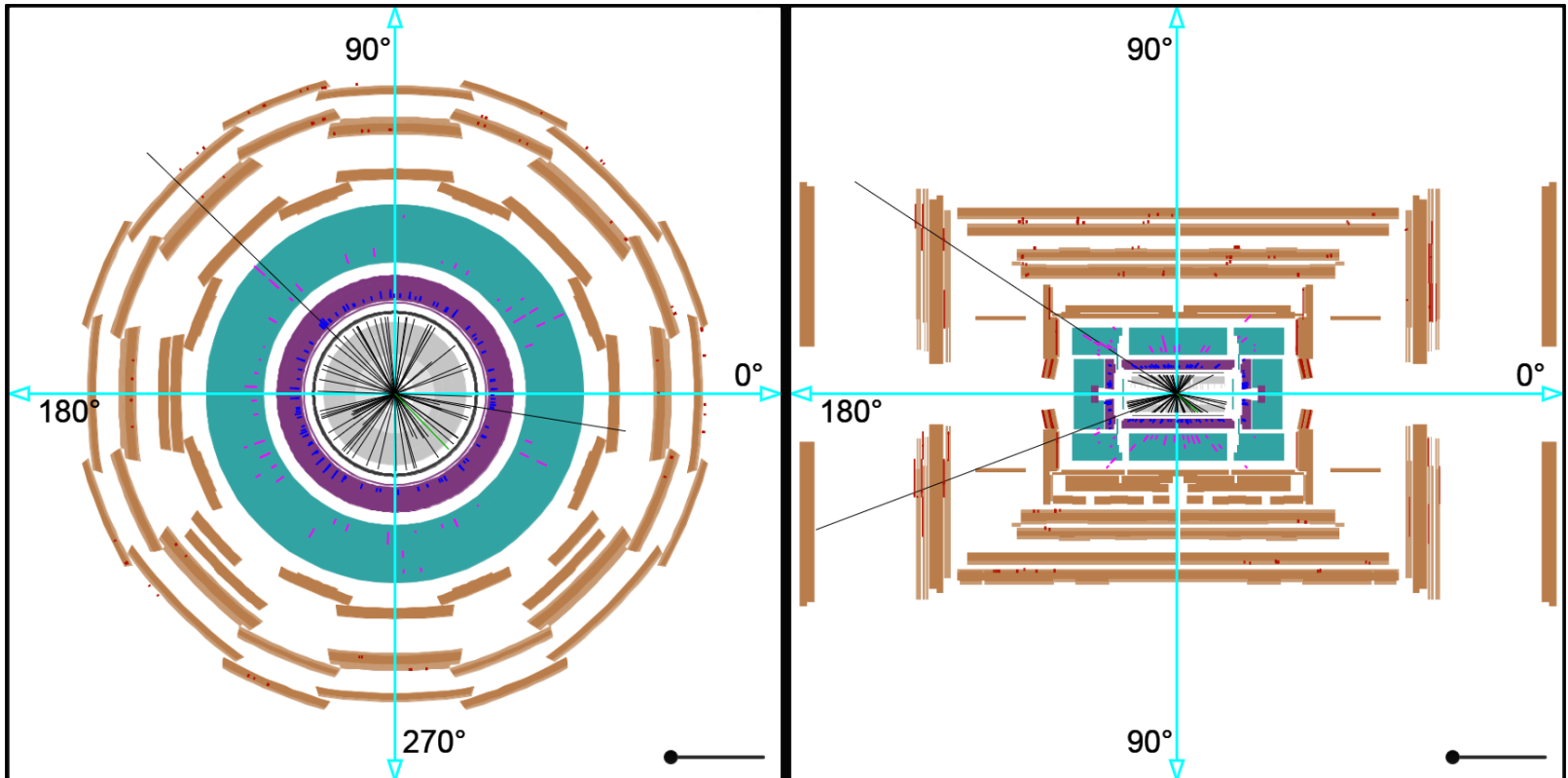

x-y view: measure ϕ

z-y view: measure θ

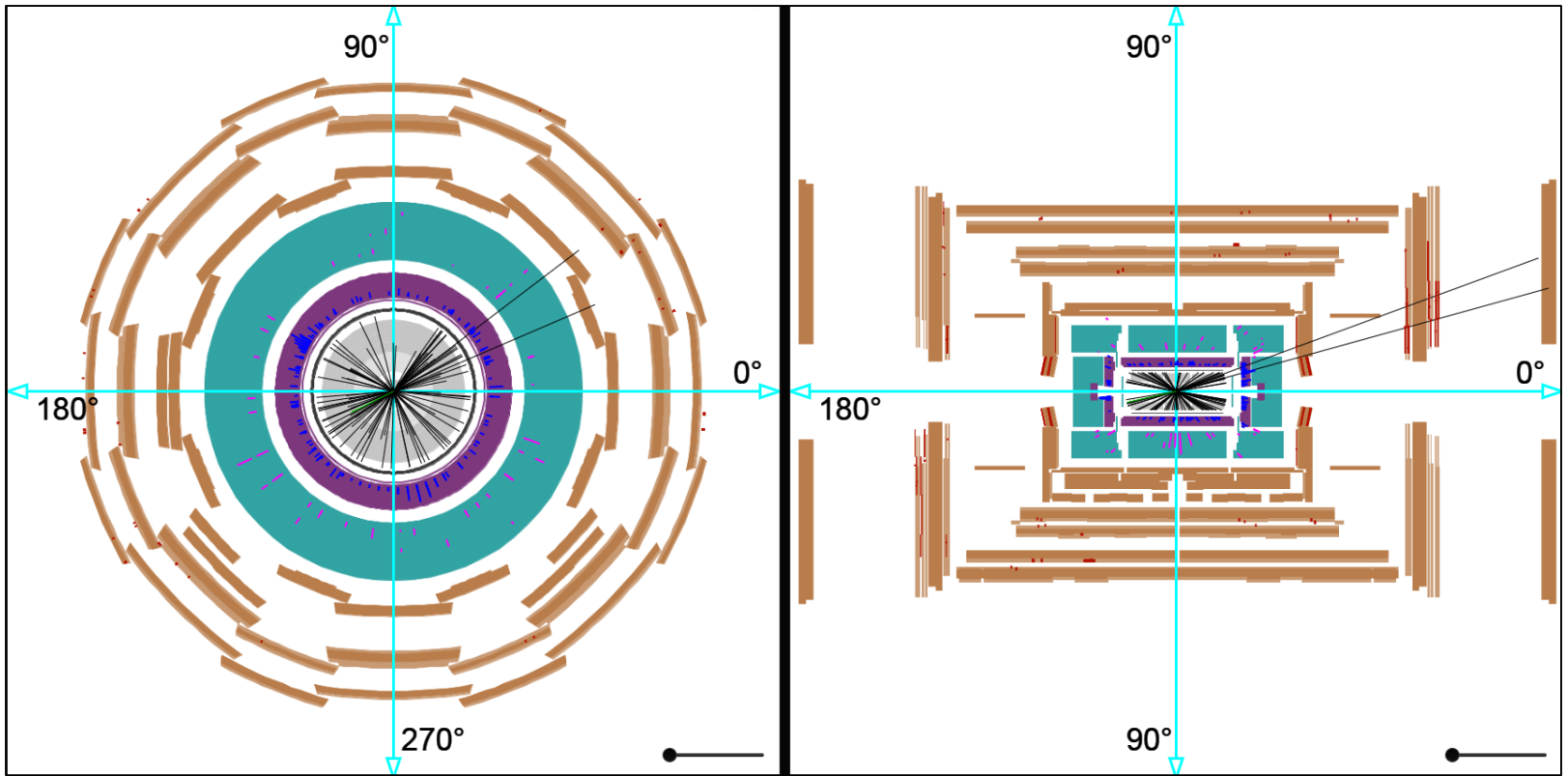

x-y view: measure ϕ

z-y view: measure θ

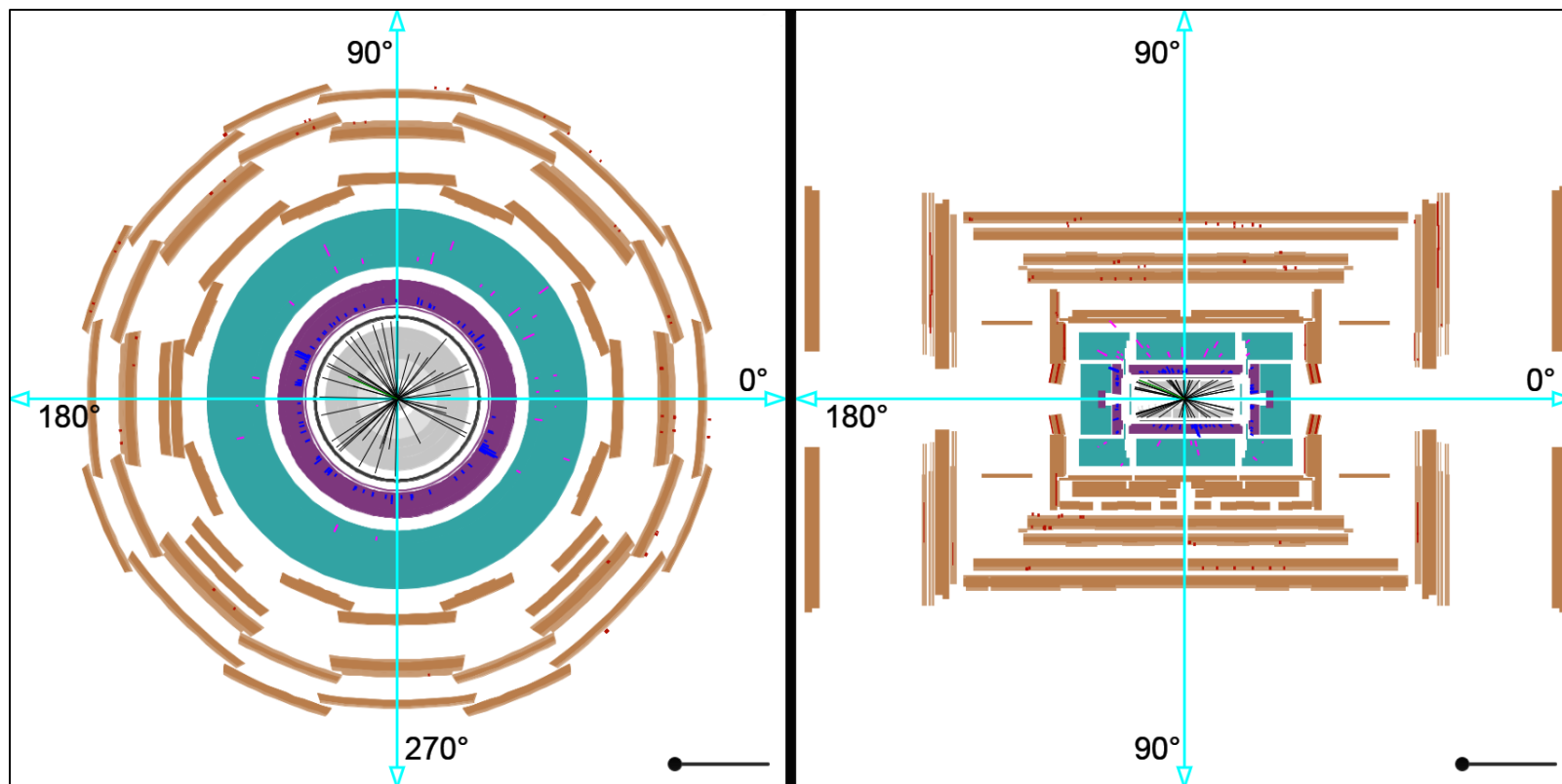

x-y view: measure ϕ

z-y view: measure θ

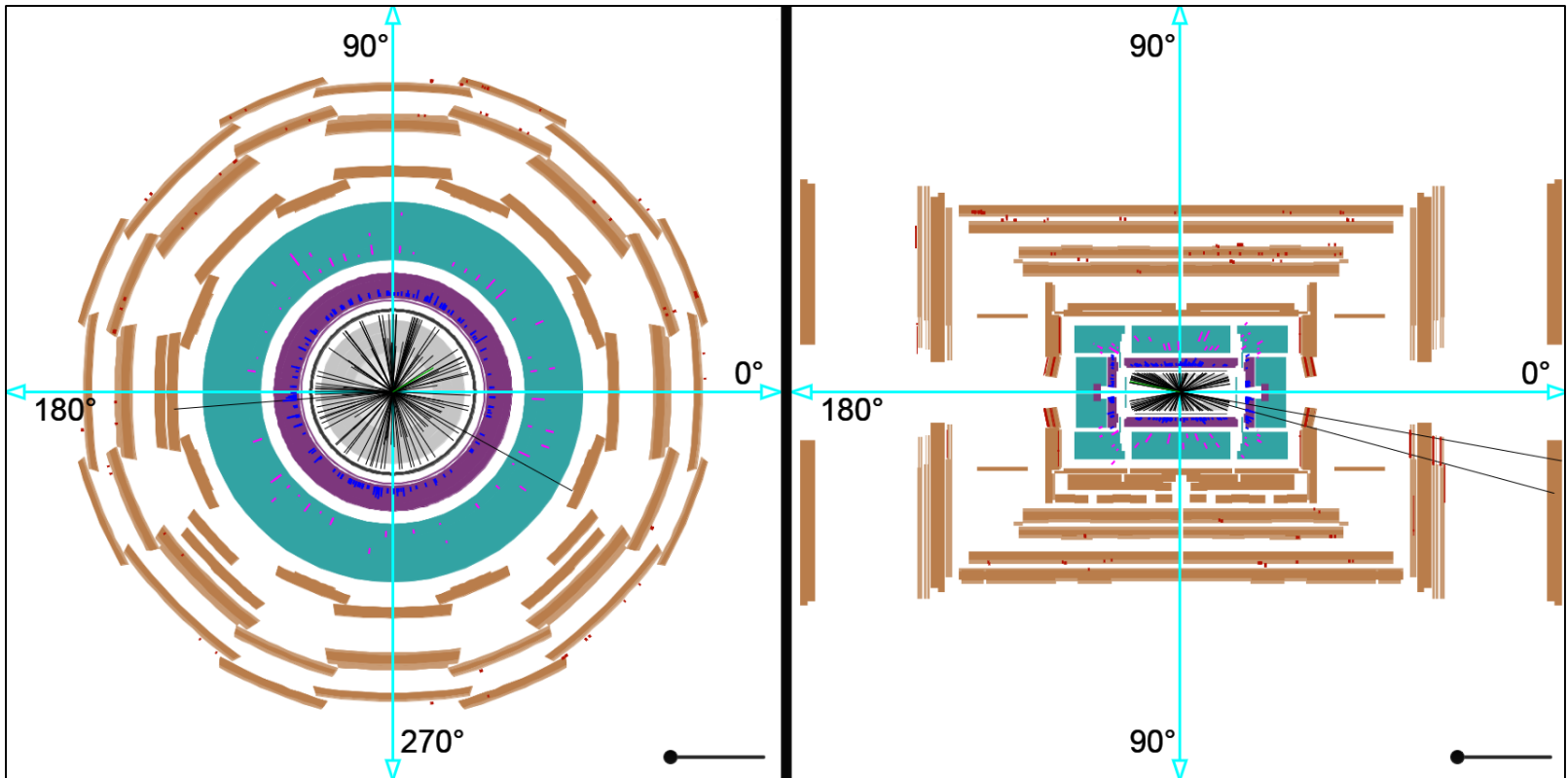

x-y view: measure ϕ

z-y view: measure θ

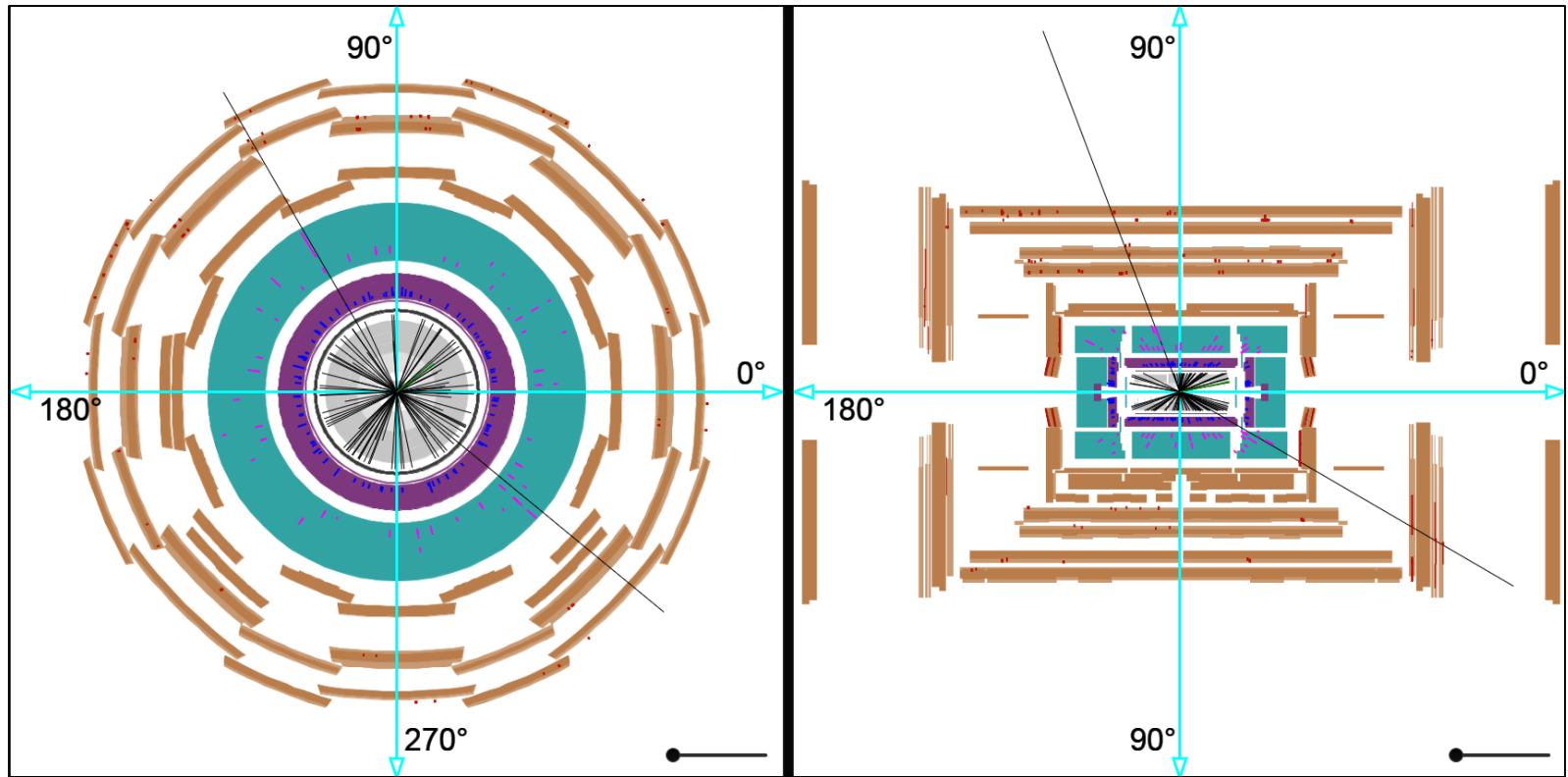

x-y view: measure ϕ

z-y view: measure θ