

Neutrinos: Mystery and History

Rick Dower

Charles T. Bauer Professor of Science,
Emeritus
Roxbury Latin School

In radioactive decay, α particles (He^{++}) and γ rays (photons) emerge from the nucleus with discrete, characteristic energies. WHY?

- Examples:



Energy and Momentum Conservation

- When a nucleus (known mass) at rest decays to two particles (known masses), two equations (energy and momentum conservation) combine to determine the two velocities of the resultant particles and, hence, their energy and momentum values.
- Discrete energy values of α and γ particles result from energy and momentum conservation.

Does β -decay conserve energy and momentum?

James Chadwick

(1935 Nobel Prize for Neutron Discovery)



β -decay is unlike α - or γ -decay

- α and γ decays have discrete characteristic energies that conform to energy and momentum conservation.
- In 1914 Chadwick observed the continuous energy spectrum of β -decay electrons.
- The continuous β -spectrum was confirmed by more precise measurements in 1927-1929.

β -spectrometer

1/25/12 Spectrometer available from The Science Source in Maine Internet: www.thesciencesource.com Phone: 1-800-299-5469
 GM tubes, counters, sources available from Spectrum Techniques, Oak Ridge, TN Internet: www.spectrumtechniques.com

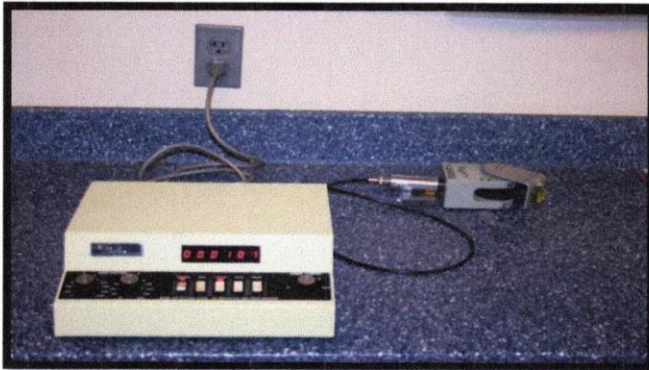

Nucleus Model 500 Scaler with 25 mm GM tube

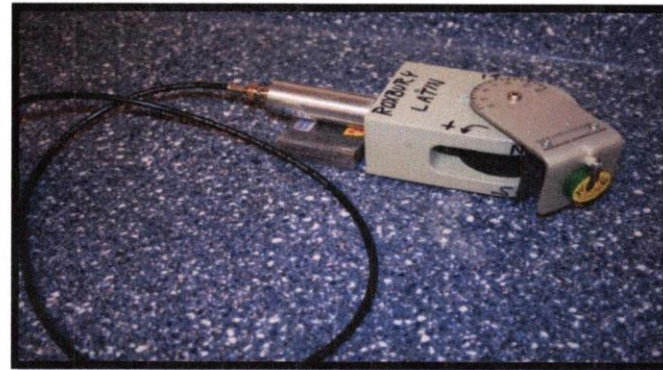

Spectrograph with beta source and GM tube
 B field vertically down across magnet pole gap
 e^+ curve toward left. e^- curve toward right.

Two ceramic disk magnets supported on an iron yoke

Magnet diameter: $d = 6.2$ cm Measured 12/12/2011 by RGD

Magnet separation: $s = 1.2$ cm Measured 5/30/2012 by RGD

Magnetic field (B) measured with current balance 1/19/2012 by RGD:

$$F_{\text{mag}} = mg = ILB$$

$m =$ mass of #30 wire that balances magnetic force = 0.45 g for 100 cm wire

$L =$ length of current balance loop wire \perp to magnetic field

$I =$ current required to balance weight of #30 wire = 0.85 A for 100 cm #30 wire on balance

Magnetic field: $B =$	0.0665 tesla	for $L =$	7.8 cm	distance between centers of vertical wires
$B = mg/IL$	0.0692 tesla	for $L =$	7.5 cm	better value for $L \perp$ to B
	0.0701 tesla	for $L =$	7.4 cm	

Current Balance Wire Shape

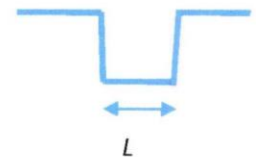

β -spectrometer

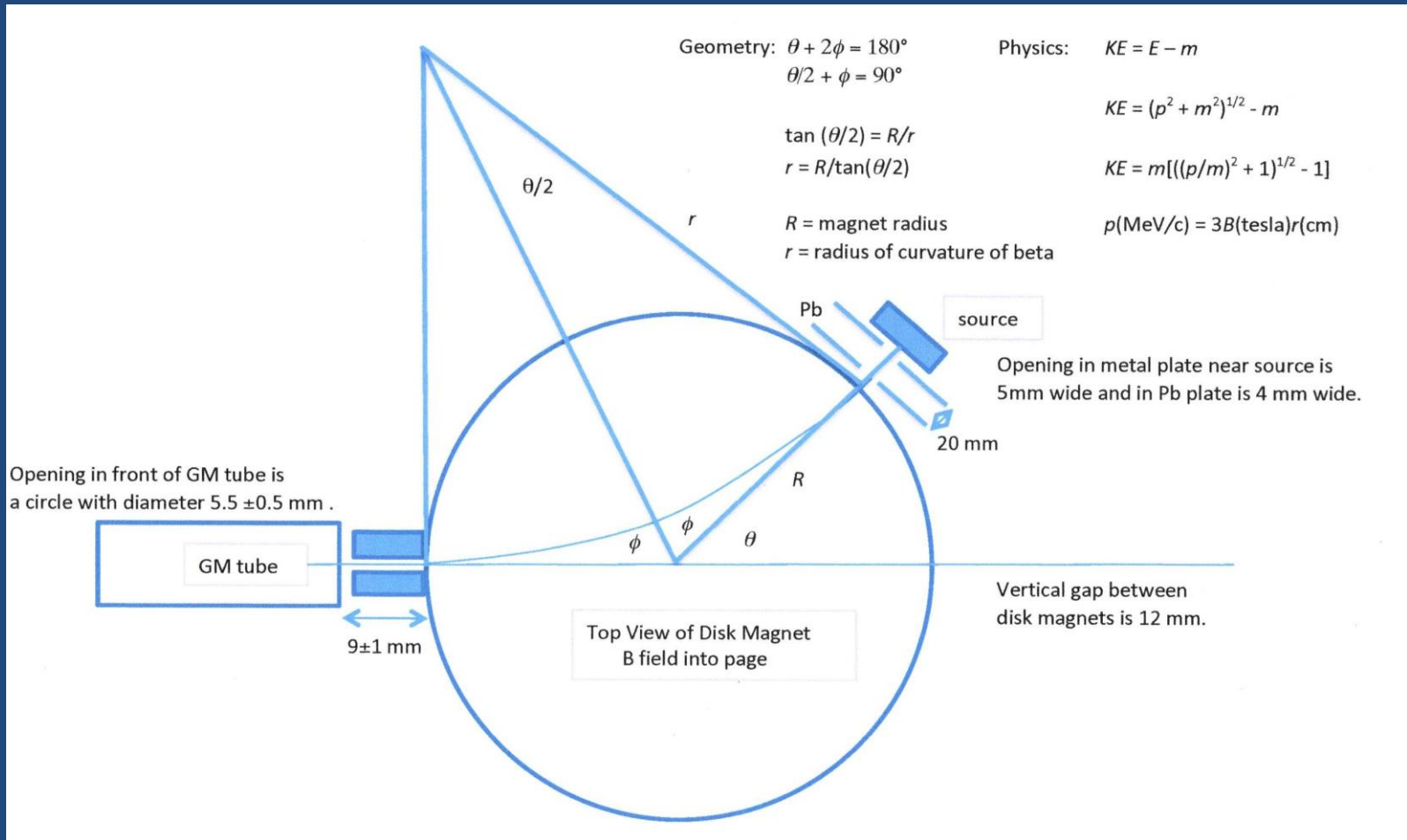

β -decay Energy Spectra

Sr-90 ((Counts/min) - Bkgd)/MeV for $\Delta\theta = 5^\circ$

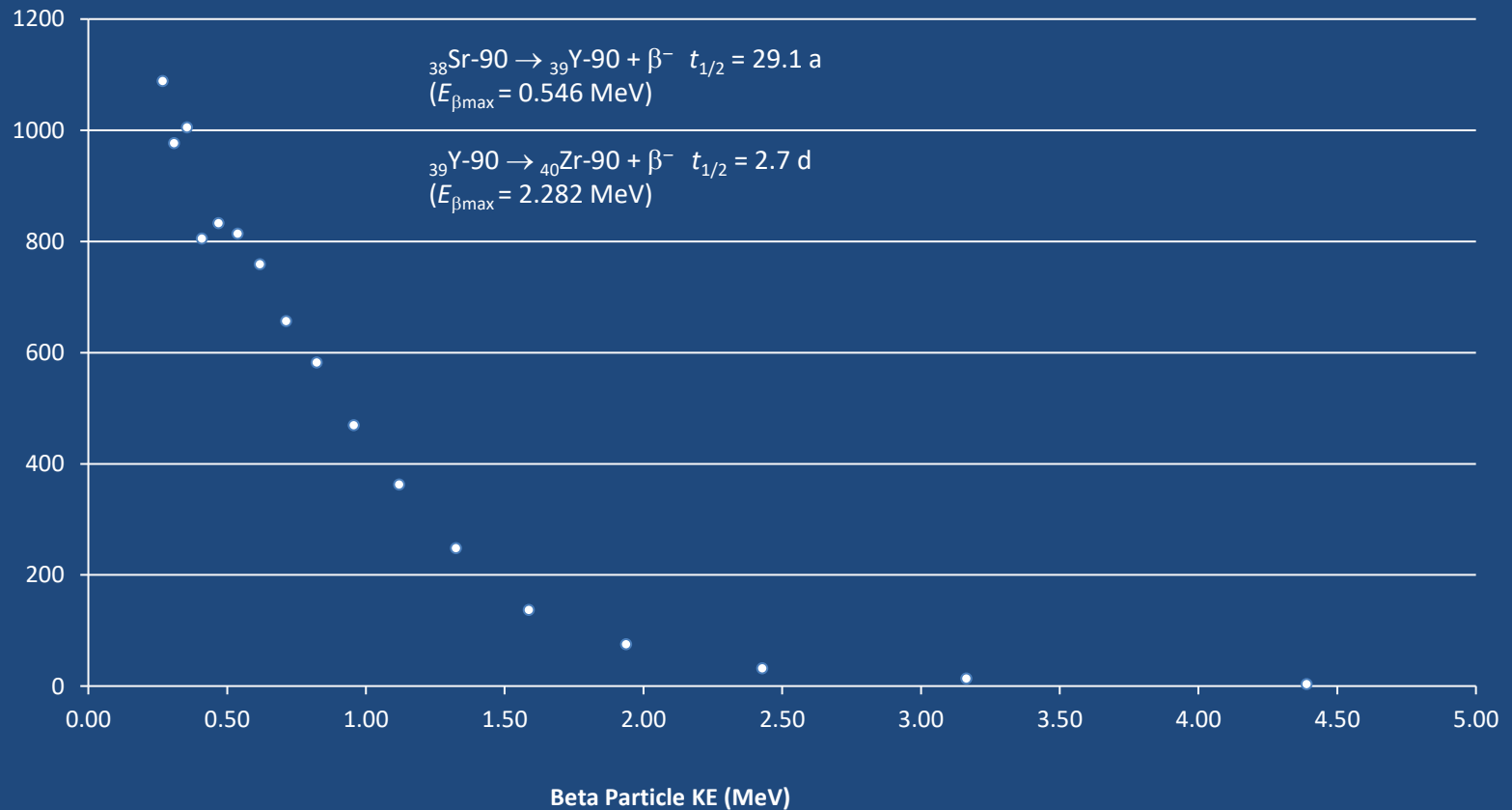

“A desperate remedy”

Wolfgang Pauli

(1945 Nobel Prize for Exclusion Principle)



“Lieb Radioaktive Damen und Herren”
“Dear Radioactive Ladies and Gentlemen”

- In his 1930 letter, Pauli proposes a very low mass neutral particle, which he calls a “neutron,” emitted in β -decay along with the electron “such that the sum of the energies of neutron and electron is constant.”
- In 1932, Chadwick discovered the neutron ($m_n \cong m_p$) ejected in α -Be collisions.
- In 1934, Enrico Fermi proposed a theory of β -decay with Pauli’s particles renamed “neutrinos.”

How do you detect a poltergeist?

Fred Reines
(1995 Nobel Prize for neutrino observation)



Fred Reines and Clyde Cowan



In 1956, Fred Reines and Clyde Cowan detected electron antineutrinos from the Savannah River nuclear reactor and sent a cable to inform Wolfgang Pauli.

First, $\bar{\nu}_e + p^+ \rightarrow n + e^+$.

Then $e^+ + e^- \rightarrow \gamma + \gamma$.

γ -rays detected by photomultiplier tubes produce a current spike.

$e^+e^- \gamma$ -rays are followed several μs later by :

$n + \text{Cd-108} \rightarrow \text{Cd-109}$

Then $\text{Cd-109} \rightarrow \text{Cd-109} + \gamma$ -rays

Second current spike within 30 μs indicates a neutrino interaction.

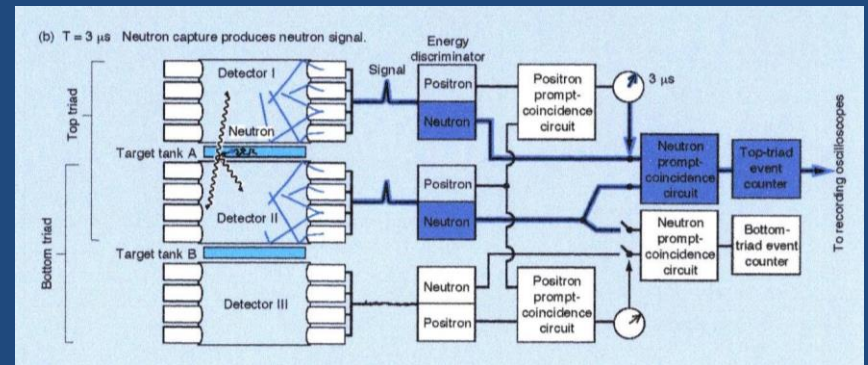
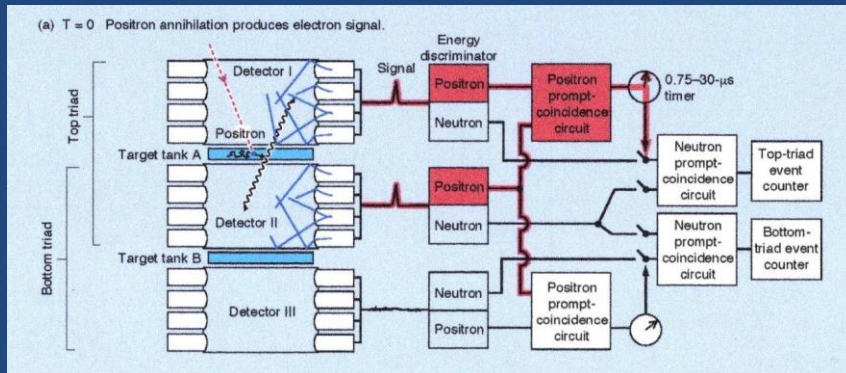

In 1936, the muon (μ) was discovered
in cloud chamber photos.

“Who ordered that?” – I. I. Rabi

Carl Anderson

(1936 Nobel Prize for e^+ discovery)

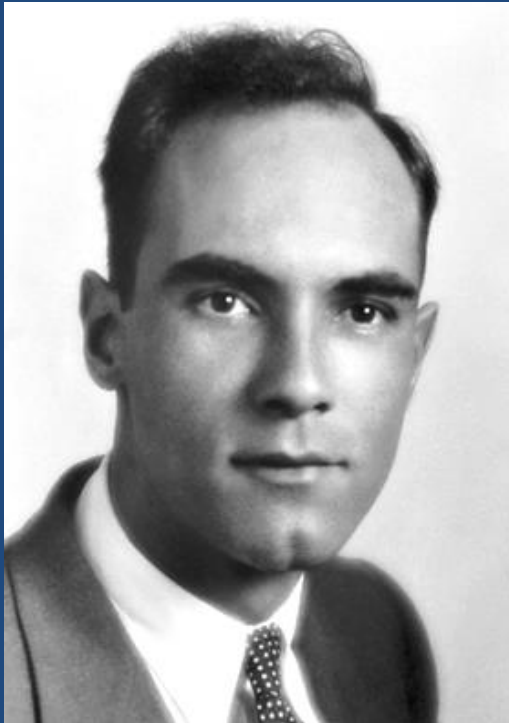

Seth Neddermeyer

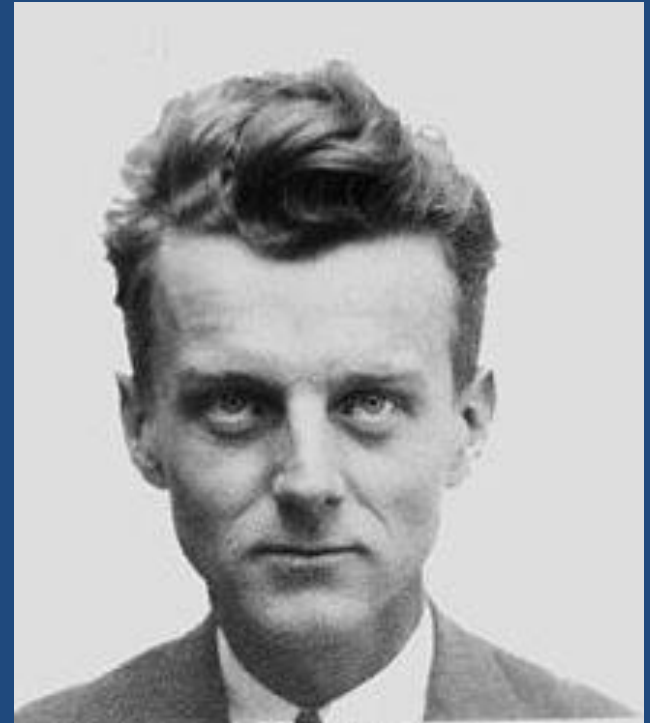

Muons disintegrate to electrons and ?

- In 1940, E. J .Williams and G. E. Roberts make the first observation in cloud chamber photos of muon decay:



- In 1941-1942, F. Rasetti, B. Rossi, and N. Nereson measure the muon mean lifetime with coincidence and anticoincidence counters:

$$\tau_{\mu} = 2.15 \pm 0.07 \mu\text{s}.$$

In 1947, Cecil Powell and his team discovered the pion and observed pions (π) decay to muons (μ) in nuclear emulsion images of cosmic ray tracks.

Cecil Powell
(1950 Nobel Prize for π discovery)

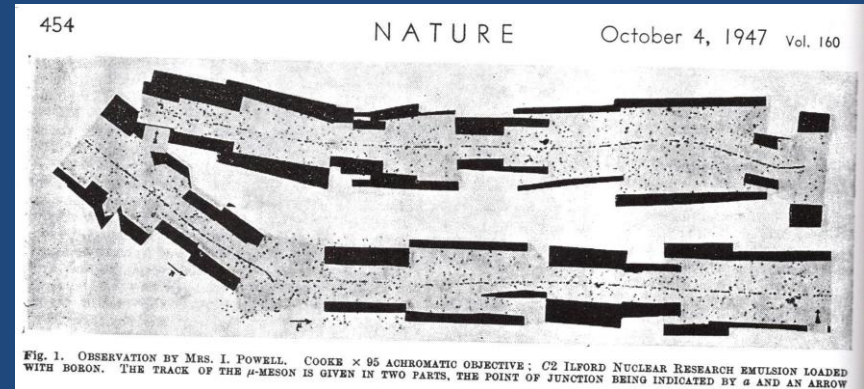
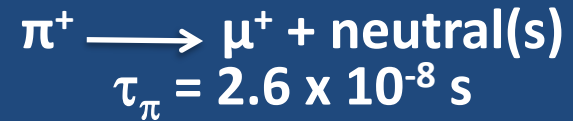

How did a Navy cruiser (like the USS Salem) help show that neutrinos come in two flavors?

1988 Nobel Prize for ν_μ discovery

USS Salem



In 1962, at Brookhaven AGS, 15-GeV protons on a Be target produced pions. Pions decayed, $\pi^+ \rightarrow \mu^+ + \nu_\mu$. Muons stopped in 13.5 m of steel from a dismantled cruiser. A 10-ton spark chamber detected 29 muons produced by neutrinos, $\nu_\mu + n \rightarrow p^+ + \mu^-$, with 5 of 34 single track events from cosmic rays. Shower track distribution is unlike electron shower distribution.

Conclusion: $\nu_\mu \neq \nu_e$

Experiment Lay Out

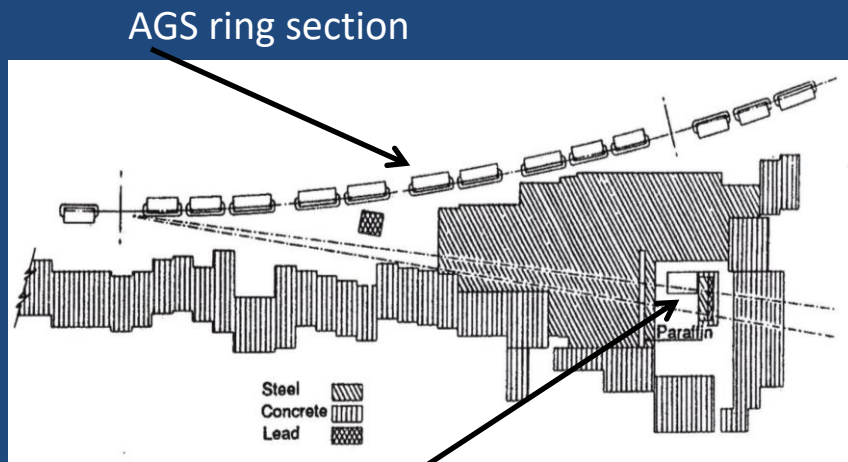

Muon Track in Spark Chamber (Sparks between vertical Al plates)

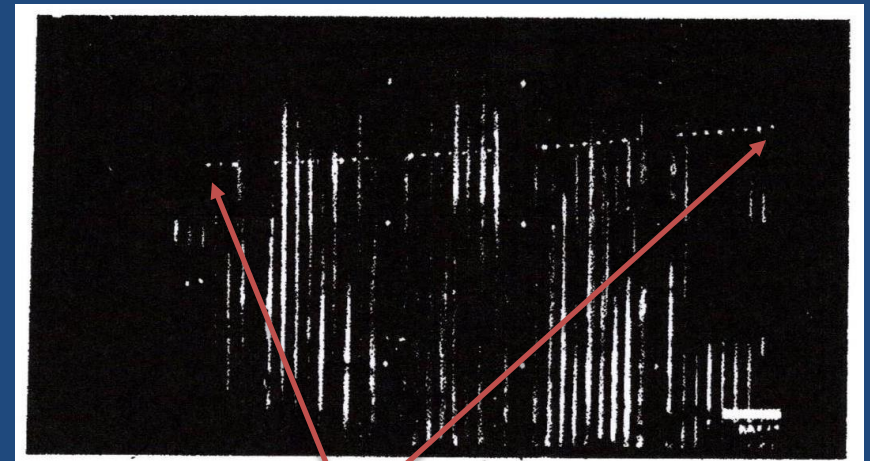

Third Generation Neutrino?

In 1975, a third-generation charged lepton (τ) was discovered by Martin Perl and colleagues with SPEAR (4 GeV/beam) e^+e^- collider.

Martin Perl
(1995 Nobel Prize for τ discovery)



**Tau (τ) lepton and tau neutrino (ν_τ)
implied by observations**

- 64 events observed
 $e^+ + e^- \longrightarrow e^+ + \mu^- + \text{neutrals}$
 $e^+ + e^- \longrightarrow e^- + \mu^+ + \text{neutrals}$
- New lepton (τ) proposed with mass $1.6 < m_\tau < 2.0 \text{ GeV}/c^2$ and accompanying neutrino. The τ particles decay ($3 \times 10^{-13} \text{ s}$) to produce observed particles, *e.g.*
 $e^+ + e^- \longrightarrow \tau^+ + \tau^-$ followed by
 $\tau^+ \longrightarrow e^+ + \nu_e + \bar{\nu}_\tau$
and $\tau^- \longrightarrow \mu^- + \bar{\nu}_\mu + \nu_\tau$

2000 – Fermilab DONuT Collaboration announces Tau Neutrino (ν_τ) detection

Neutrino Beam Production

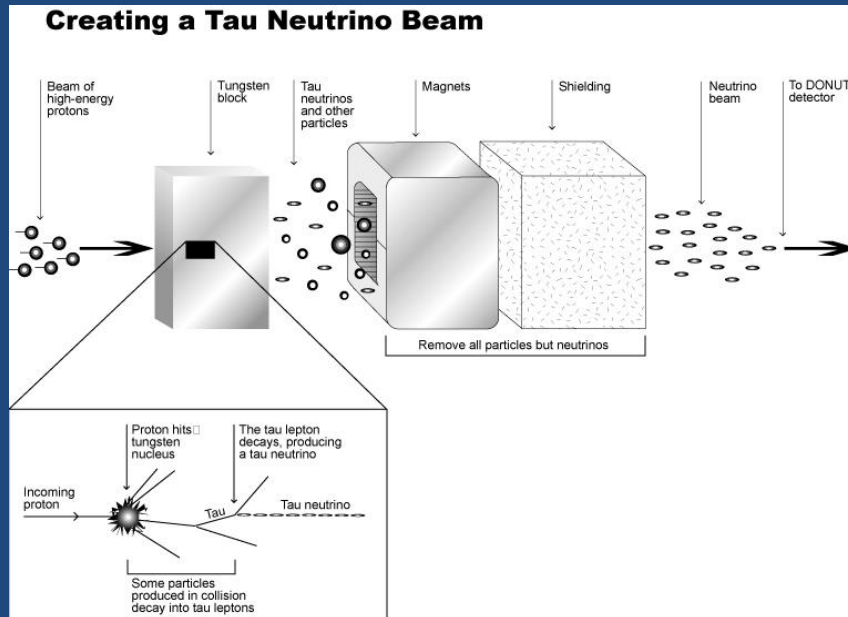

Combination of detector technologies used to identify ν_τ

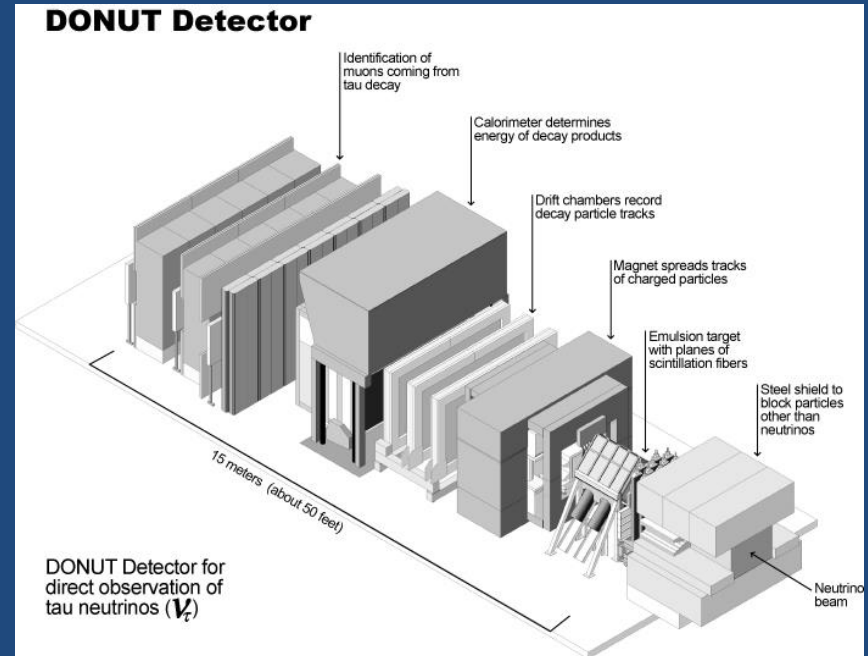

Direct Observation of Nu Tau (DONuT)

- 6,600,000 triggered events detected
- 4 kinked tracks - decays of tau leptons produced by ν_τ : $\nu_\tau + n \rightarrow p^+ + \tau^-$, followed by τ decay.

Detecting a Tau Neutrino

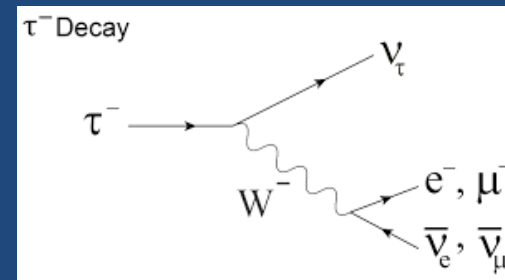
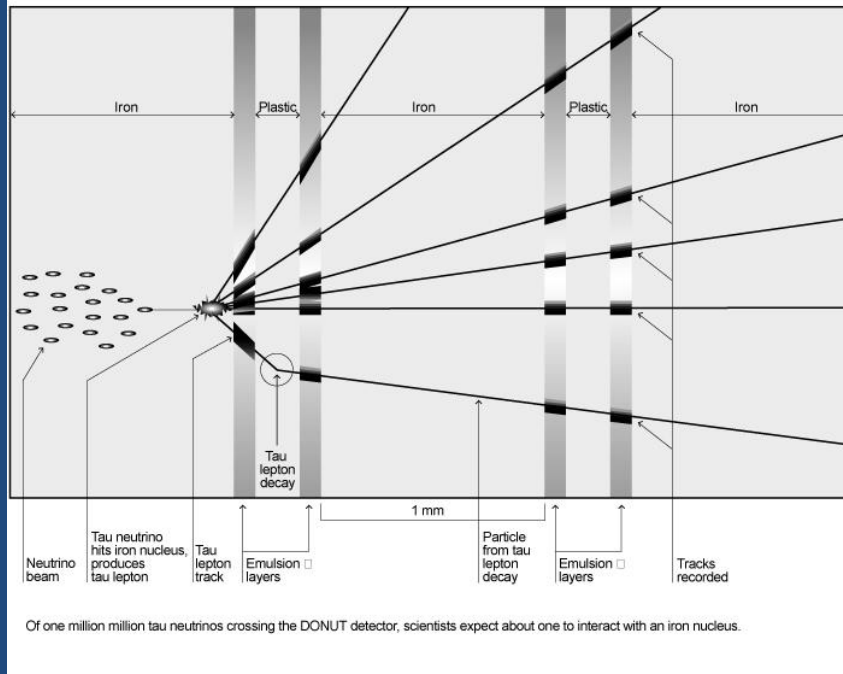

1968 – Sheldon Glashow, Abdus Salam, Steven Weinberg independently propose electroweak interaction theory.

Weinberg, Glashow, Salam

1979 Nobel Prize for electroweak theory



Predictions

- Existence of massive charged weak bosons (W^+ and W^-) that mediate charged particle decay.
- Existence of massive neutral weak boson (Z) that mediates neutrino scattering.
- Massless photon (γ) mediates electromagnetic interactions.

1973 – Weak neutral current neutrino interaction observed in Gargamelle bubble chamber at CERN, as predicted.

Gargamelle Bubble Chamber filled with liquid Freon (CBrF_3)



The 1984 Nobel Prize was awarded to Carlo Rubia and Simon van der Meer for the detection of W^\pm and Z at CERN in 1983.

Gargamelle image of weak neutral current (ν_μ scattering from electron)

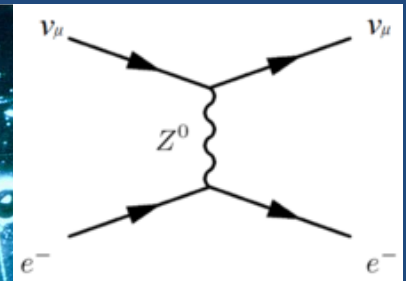
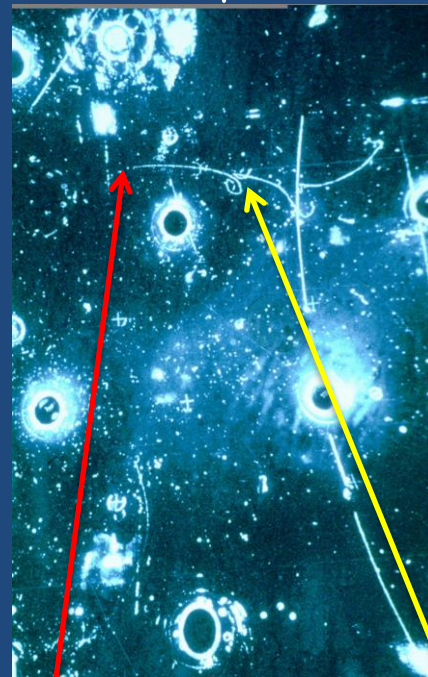

ν_μ beam enters from left and scatters e^- which radiates γ that forms e^+e^- pair.

How many neutrino types are there?

$e^+ + e^- \rightarrow$ hadrons: Cross Section and Standard Model Predictions

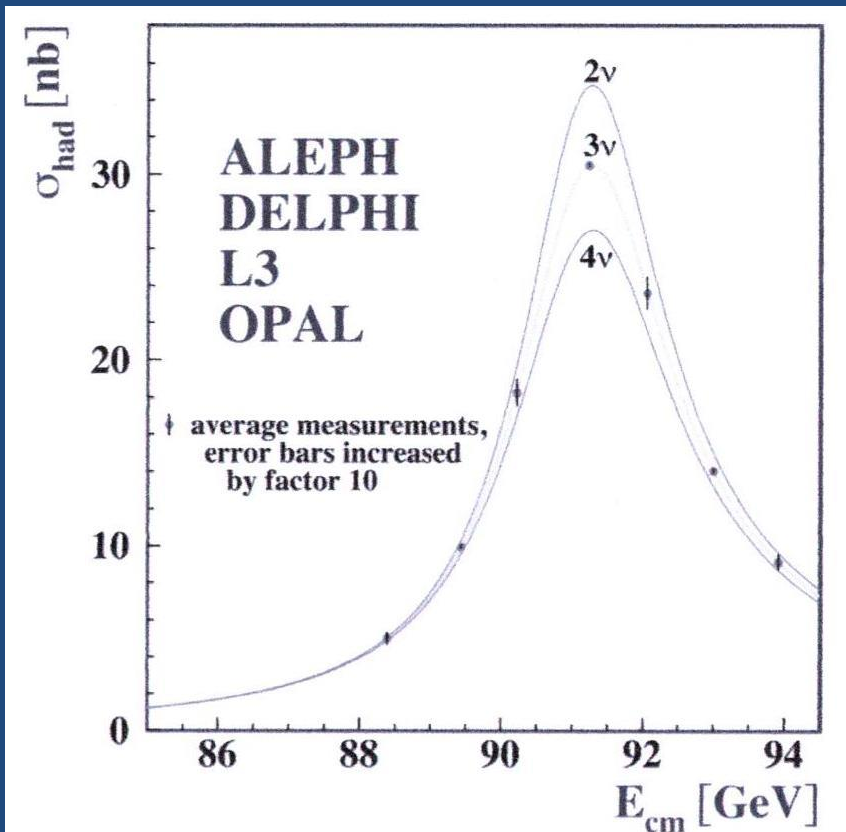

Large Electron Positron (LEP) collider at CERN (1989 – 2000) in 27 km tunnel now occupied by the LHC. Initial beam energy = 45 GeV. Final beam energy = 209 GeV.

- By measuring the cross section for Z production and the branching ratio of the Z decays into visible hadrons and leptons, theorists can determine the fraction of Z decays into neutrinos and the number of light neutrino families (N_ν).
 $N_\nu = 2.9841 \pm 0.0083$

How fast do neutrinos travel?

In Type II supernovae: $p^+ + e^- \longrightarrow n + \nu_e$

(Supernova neutrinos Predicted by Bruno Pontecorvo in 1958.)

Type II core-collapse supernova
SN1987A, 168,000 ly away in
Large Magellanic Cloud,
produced a neutrino pulse.



Neutrinos observed 2-3 hr
before supernova light noticed –
12 by Kamiokande II (Japan),
8 by IMB (USA), 5 by Baksan
(USSR) in 13 seconds.

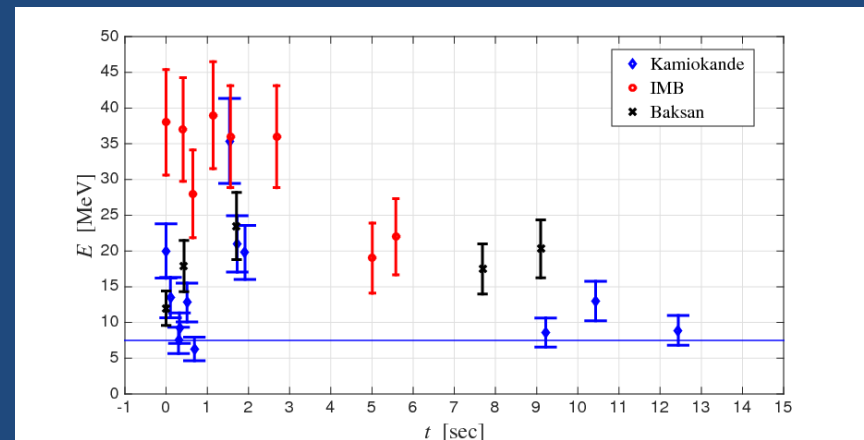

What is the solar neutrino problem?

John Bahcall's solar model and Ray Davis's (2002 Nobel Prize) experiment (1970-1994)



- Ray Davis with 380,000 liter tank of perchloroethylene ($\text{Cl}_2\text{C}=\text{CCl}_2$) in Homestake Mine, Lead, South Dakota – 1478 m below surface.
- 24% of CL is ^{37}Cl for reaction:
$$\nu_e + {}^{37}\text{Cl} \longrightarrow {}^{37}\text{Ar} + e^-$$
- ^{37}Ar is radioactive with $t_{1/2} = 35$ d.
$${}^{37}\text{Ar} + e^- \longrightarrow {}^{37}\text{Cl} + \nu_e$$

(electron capture)
- 3×10^{19} atoms of ^{36}Ar mixed into tank. Tank accumulates ^{37}Ar for about 3 months. Then tank is purged with He, Ar is collected, ^{36}Ar measured, and ^{37}Ar atoms counted.
- 1/3 of predicted ν_e detected.
This is the solar neutrino problem.

Solar Neutrino Problem

- Theorists: “Experiment is probably faulty.”
- Experimenters: “Solar model is probably wrong.”
- With at least 0.814 MeV ν_e energy required for ^{37}Cl interaction, the Davis experiment was sensitive to a minor reaction in Sun’s core.
- Soviet-American Gallium Experiment (SAGE) in Russia (1989, ongoing with about 50 tons of liquid Ga) and the Gallium Experiment (GALLEX) in Italy (1991-1997, about 30 tons of Ga in $\text{GaCl}_3\text{-HCl}$ solution) examined ν_e ($E_{\nu_e} > 0.233$ MeV) produced by the dominant lower energy pp and pep reactions. **Confirmed ν_e deficit.**
 $^{71}\text{Ga} + \nu_e \longrightarrow ^{71}\text{Ge} + e^-$, $^{71}\text{Ge} + e^- \longrightarrow ^{71}\text{Ga} + \nu_e$ ($t_{1/2} = 11.4$ d)

Kamioka Nuclear Decay Experiment (KamiokaNDE in a Japanese zinc mine)

Detector Model showing tank for 3×10^6 L of water surrounded by 1000 PMT to observe Čerenkov light from electrons and muons

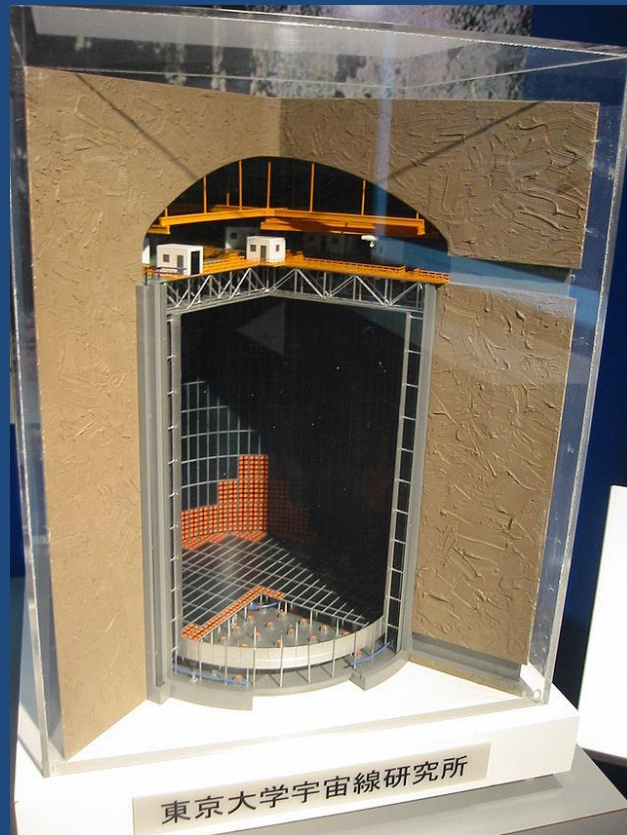

High energy electrons and muons traveling faster than light speed in water produce Čerenkov radiation rings. Detector sensitive to atmospheric and solar neutrinos.

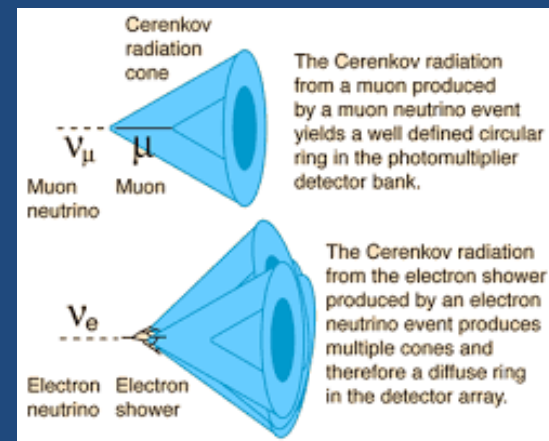
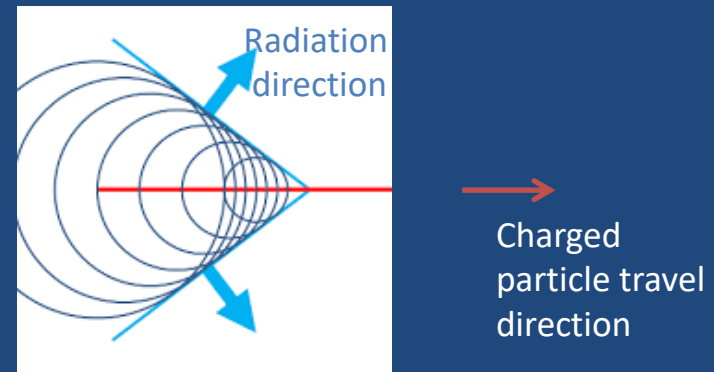

Atmospheric Neutrinos

- Cosmic rays interact with atmosphere atoms to produce pions. Then $\pi^\pm \longrightarrow \mu^\pm + \nu_\mu, \bar{\nu}_\mu$ is followed by $\mu^\pm \longrightarrow e^\pm + (\nu_e, \bar{\nu}_e) + (\bar{\nu}_\mu, \nu_\mu)$.
- Twice as many muon as electron atmospheric neutrinos were expected in the Kamiokande detector.
- For high energy cosmic rays, the resulting pions, muons, and neutrinos travel roughly in the direction of the incident cosmic rays. The location of the Čerenkov ring in the detector indicates the direction of the neutrino.

What types of neutrinos produced these rings?
From what direction?

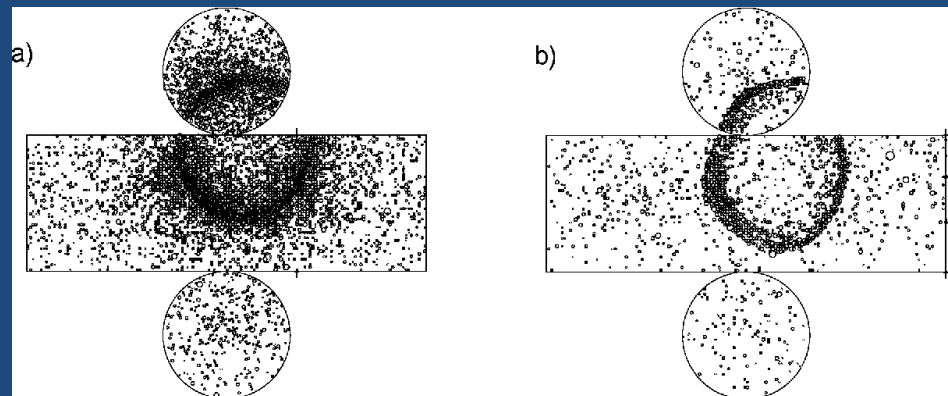

Kamiokande

- The Kamiokande detector (1983-1995) was originally developed by Masatoshi Kobshiba (2002 Nobel Prize) to search for proton decay (not observed) and neutrinos from cosmic rays.
- Kamiokande experimenters observed enhanced neutrino flux from Sun's direction.
- Fewer atmospheric muon neutrinos than expected entered Kamiokande from below, *i. e.* through Earth .
- The success of Kamiokande led to the construction of Super-Kamiokande (1996-present) with 50×10^6 L of ultra-pure water and 11,200 PMTs.

Sudbury Neutrino Observatory (SNO deep in a Canadian Nickel mine)

- Detector is an acrylic sphere containing 10^6 kg of D_2O surrounded by 9600 PMTs in a chamber 2100 m below ground.

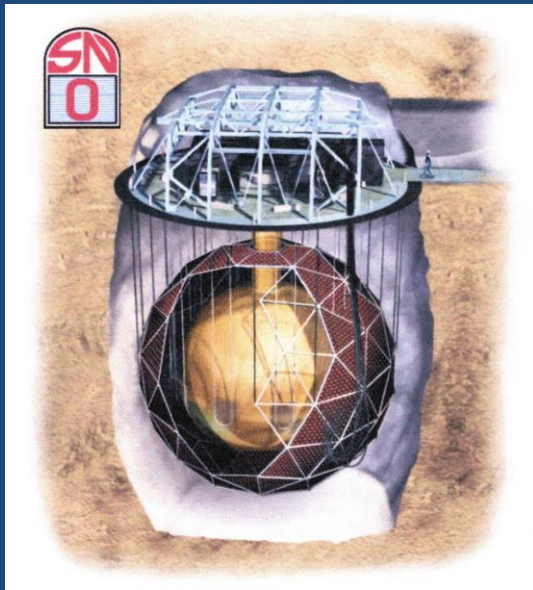

- SNO detector (1999-2006) responds to elastic scattering (ES) of neutrinos from atomic electrons, charged current (CC) reaction, and neutral current (NC) reactions with deuterons (d):
$$\nu_x + e^- \longrightarrow \nu_x + e^- \quad (\text{ES})$$
$$\nu_x + d \longrightarrow p + n + \nu_x \quad (\text{NC})$$
$$\nu_e + d \longrightarrow p + p + e^- \quad (\text{CC})$$
$$x = e, \mu, \tau$$
- ES shows ν direction (e.g. from Sun)
- NC: $n + d \longrightarrow {}^3\text{H} + \gamma$ (6.25 MeV), then γ photon Compton scatters electron to make Cerenkov light
- CC shows (solar) ν energy spectrum

Neutrino Oscillations

- Super-Kamiokande and SNO data confirm results of the Davis, SAGE, and Gallex experiments.
SNO results: Total neutrino flux of all flavors matches the ν_e flux predicted by the Standard Solar Model (John Bahcall).
- As proposed by Bruno Pontecorvo in 1969, neutrinos can apparently change flavor in flight. Therefore, they must have a non-zero mass, contrary to the Standard Model assumption.
- 2015 Nobel Prize awarded to Takaaki Kajita (Super-K) and Arthur McDonald (SNO) for their discoveries that led to this conclusion.

Current Questions

- What parameters determine neutrino oscillations?
- What are the neutrino masses?
- Are neutrinos their own antiparticles?
- Do sterile neutrinos exist?
- What is the source of ultrahigh energy neutrinos?